



Not all products are qualified on the DLC QPL. To view our DLC qualified products, please consult the DLC Qualified Products List at [www.designlights.org/qpl](http://www.designlights.org/qpl)

**\*\* AVAILABLE \*\***

Bi-Level Dimming  
100% 50%

0 - 10V  
FULL DIMMING

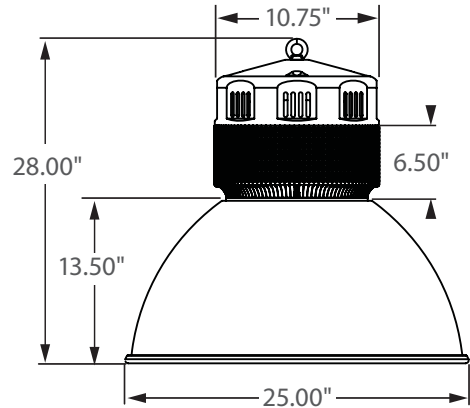

Incredible **100,000 hrs**

### GENERAL DESCRIPTION

Neptun's LED 25" Polycarbonate High-Bay fixtures combine classic form and versatility to make it an excellent choice for new construction or retrofit applications. The polycarbonate refractor offers excellent optics with horizontal and vertical footcandles. The 25" housing is offered in a variety of wattages to provide maximum flexibility in all types of applications. It can replace existing HID & HPS fixtures up to 1000W.

### APPLICATION

- Warehouse Lighting
- Factory Lighting
- Retail Lighting
- Showroom Lighting
- Grocery Store Lighting
- Area & Storage Lighting
- Gymnasium Lighting

### STRUCTURE, MATERIALS, & FEATURES

- 25" High Efficiency, heat and impact resistant, UV protected, non yellowing, polycarbonate refractor.
- Corrosion resistant die-cast aluminum gear box with electrocoat finish.
- High Output COB LED's.
- High power factor, low THD driver with 6kV/3kA surge protection.
- High performance Thermal Management system.
- Instant-On flicker-free Cold Start and Hot Re-Start.
- Bright white light (5000°K) for greater visibility and safety.
- Up to 15 year maintenance free operation.
- 5 Year Warranty on complete fixture. (LED's, Driver, & Housing)
- **Optional:** Bi-Level Dimming, 0-10V Dimming, Wi-Fi Control, Remote Monitoring and ON/ OFF Control

### ORDERING INFORMATION

Sample Number: LED-25250-PC-UNV-BL-DIM-850-MD-C3  
Custom options and accessories available. Please consult factory

Series	Wattage	Reflector	Voltage	Options	CCT	Accessories	Options
LED-25 = 25" High Bay	200 = 200 W 250 = 250 W 300 = 300 W 400 = 400 W	PC = Polycarbonate	UNV = 120-277 VAC 347V = 347 VAC 480V = 480 VAC	0-10VDIM = 0-10V Dimming BL-DIM = Bi-Level Dimming * * Includes Motion Sensor ** Contact Factory for dimming options	835 = 3500°K 841 = 4100°K 850 = 5000°K * * Standard	MD = Motion Sensor ON/OFF DLH = Day Light Harvesting* * Offered with 0-10V Dimming)	C3* = 3' Cord-No Plug (other lengths available C6 = 6' cord) PC3 = 3' Cord with NEMA Plug (verify plug type when ordering) PL = Polycarbonate Lens PDM = 3/4" Knockout * Standard



### PRODUCT INFORMATION

Model No.	Description	Rated Watts	Input Watts	Delivered Lumens	Universal Line Voltage (VAC)	Max Line Current (Amp) @ 120 - 277	THD	Power Factor	Weight
LED-25200-PC-UNV	LED High Bay Fixture	200	202	22,000	120-277	1.74 - 0.75	<20%	>0.90	30 lbs
LED-25250-PC-UNV	LED High Bay Fixture	250	252	27,500	120-277	2.18 - 0.94	<20%	>0.90	30 lbs
LED-25300-PC-UNV	LED High Bay Fixture	300	301	33,000	120-277	2.62 - 1.13	<20%	>0.90	40 lbs
LED-25400-PC-UNV	LED High Bay Fixture	400	401	44,000	120-277	3.49 - 1.51	<20%	>0.90	40 lbs

### SPECIFICATIONS

- Driver ..... Constant Current
- Start Method ..... InstantON
- Hot Re-start ..... InstantON
- Power Supply ..... 350mA
- Driver UL Rating ..... Class 1
- Driver UL Outdoor Rated ..... Wet Location
- Sound Rating ..... Class A
- ANSI Surge Protection ..... IEEE C62.41 C High
- Driver Off-State Draw ..... 0 Watts
- Universal Input Line Voltage ..... 120-277 VAC
- Input Line Frequency ..... 50/60 Hz
- Projected (L70) @ 25°C ..... > 100,000 hrs.
- Color Temperature ..... 5,000°K
- Color Rendering Index (CRI) ..... > 80
- Minimum Starting Temperature ..... -40°C
- Maximum Starting Temperature ..... +50°C
- Lumens per Watt ..... > 90
- Shock / Vibration Resistant ..... Yes
- Power Factor ..... > 0.90
- Total Harmonic Distortion ..... < 20%
- Inrush Current Peak ..... < 10 Amp
- FCC Compliance ..... Part 15, Subp. C
- ETL Listed / UL Standard 1598 ..... Yes
- Housing IP Rating ..... IP43
- Driver IP Rating ..... IP67
- Warranty ..... 5 Year

### MOUNTING OPTIONS

Hook Mount (Standard)



Pendant Mount  
(Verify NPT size with factory)



### PHOTOMETRICS (See Complete IES File)

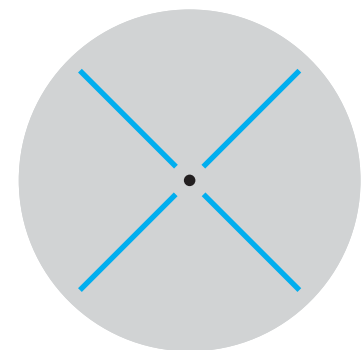

Type V Distribution