

Post top led area light



Features

- Power Factor: ≥ 0.90
- LED Chip: Philips
- CRI: $R_a \geq 70$
- Dimming: 1-10V
- 130lm/w
- Material: Aluminum alloy + PC optics lens
- Standard color: Black
- Working Temperature: $-40^{\circ}\text{F} \sim 122^{\circ}\text{F}$
- Lifespan: > 54000 hours (@ $T_c = 176^{\circ}\text{F}$)
- Total Harmonic Distortio: 18.17%

Application

Parking lots , plaza lighting ,shopping mall, garden,roadway ,site & area lighting and general lighting applications.

Ordering Information

Model	Wattage	CCT	Lumen	Input Frequency	G.W	Carton size
YR-TP890-W030	30watt	5000K	3,600lm	50/60HZ	5.2KG	700*310*310mm
YR-TP890-W060	60watt	5000K	7,500lm	50/60HZ	5.5 KG	700*310*310mm

Beam Angle

Type IV

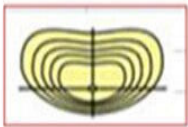

Type V

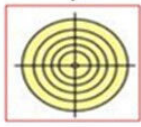

Dimension

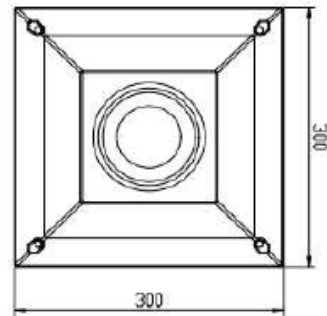
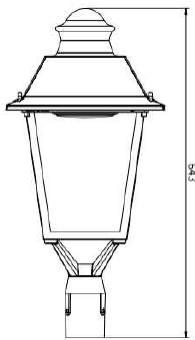

Different adaptors optional

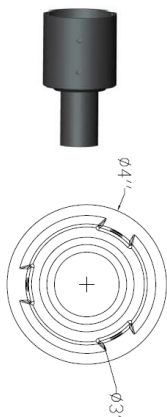
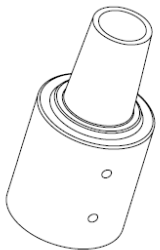

3 inch

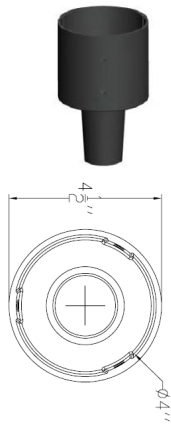

4 inch

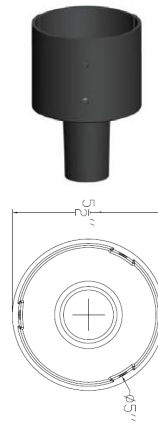

5 inch

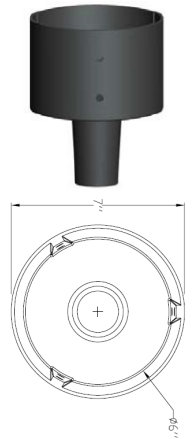

6 inch

