

LED Corn Bulb Lamp Series



5 Years Warranty



Specifications

Model	ZY120WA
Rate Power	≤126W
Input Voltage	AC100-277V 50-60Hz
CCT	2700-7000K
Power Factor	≥0.9
CRI	>80
Lumen	13500±630lm
Brand	Samsung
LED Quantity	336LEDs 0.3W
LED LM80	Yes



Samsung
LM561B



Rubycon



E39



JAE Connector

Dimension

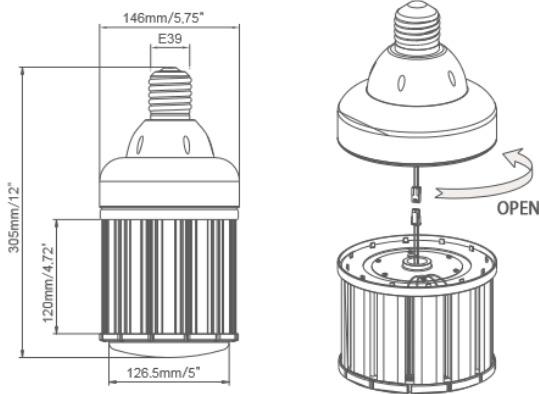

Luminous emittance

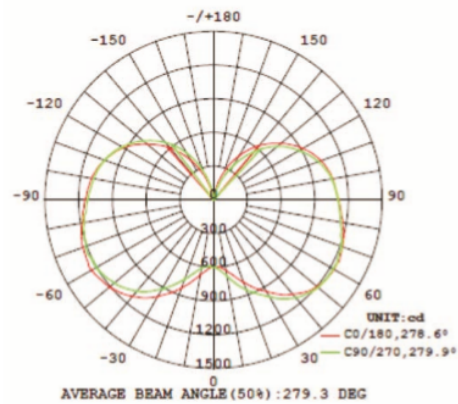

Long Lifespan of 10years

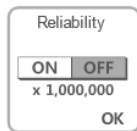

Reliability Test

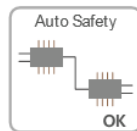

Safety Protection Circuit



No Mercury
No UVLight

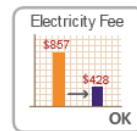

Big Saving(87%)
on Electricity Costs

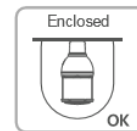

Usable in Enclosed
Luminaires



Omni Wide Angle

Installation

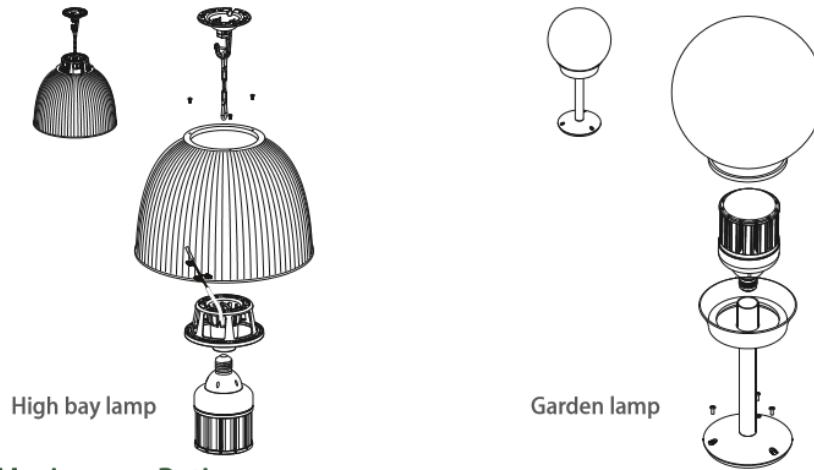

Absolute Maximum Rating

Parameter	Rating	Units
Aluminum Heat Sink Temperature	65	° C
Operating Temperature	-20→+50	° C
Storage Temperature	-40→+80	° C
Equilibrium Temperature	25	° C

Product Packing Specification

Packing Details	
Pack Quantity	4pcs
Net Weight	4lbs/1828g
Gross Weight Per CTN	19.8lbs/9kg
Box Size	7.4*7.4*13.2" 188*188*335mm
CTN Size	15.7*15.7*14" 400*400*355mm

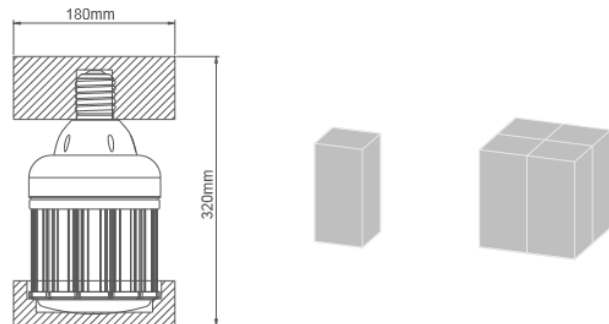

CAUTIONS

- Make sure remove the traditional ballast before replace the LED corn light.
- Don't take apart the product or replace mechanical and electronic components.
- Don't stare at the strong light for a long time as it may cause injury to eyes.