

Features

- * Customized **USA CREE** LED, 150lm/w, CRI **Ra80-93**. Junction temperature **<70° C**
- * TaiWan **MeanWell** LED Drivers, wide AC90V~305V, **PF>0.98**, low THD<9%
- * Ultra-low luminous decay **<5%** in 5 years. L70>50,000hrs. Design lifespan **80,000hrs**
- * **SONY 4D** active heat dissipation technology. Unitized module design, **biggest cooling area**
- * Constant current and constant voltage design, much more reliable than other LED floodlights
- * Japan **calculus optical DIWL lens**, light transmittance of PMMA up to 98%.
- * **10° 24° 38° 60° 90°** beam angles and excellent uniformity
- * High strength structure coated with corrosion resistant polyester powder, real **anti-corrosion**
- * Excellent optical design, low UGR. **Noflickering** for slow-motion image. Applicable to **HDTV live broadcasting**
- * Intelligent dimming system. 0-10V, **1-10V**, Triac and **DALI** dimming models are available
- * **CE RoHS TUV GS ETL FCC DLC** and **IP67** approved, **5 years warranty**
- * Widely used in stadium, sports field, tunnel, high mast lighting, light tower, ports...
Applicable for most places



Product Certification: CE\RoHS\ TUV\GS\SAA\C-Tick\ETL\FCC\DLC\IP67

Driver:



Driver certification:



Safety and EMC design refer to EN60598-1, subject 8750(UL), CNS15233, GB7000.1, FCC part18.

SAFETY & EMC	SAFETY STANDARDS <small>Note.7</small>	UL1012, CAN/CSA-C22.2 No. 107.1-01, UL8750, CSA C22.2 No. 250.0-08, TUV EN61347-1, EN61347-2-13 independent (except for HLG-240H C type), UL60950-1, UL8750, TUV EN60950-1, IP65 or IP67, J61347-1, J61347-2-13 approved
	WITHSTAND VOLTAGE	I/P-O/P:3.75KVAC I/P-FG:2KVAC O/P-FG:0.5KVAC
	ISOLATION RESISTANCE	I/P-O/P, I/P-FG, O/P-FG:100M Ohms / 500VDC / 25°C/ 70% RH
	EMC EMISSION	Compliance to EN55015, EN55022 (CISPR22) Class B, EN61000-3-2 Class C ($\geq 50\%$ load) ; EN61000-3-3
	EMC IMMUNITY	Compliance to EN61000-4-2,3,4,5,6,8,11, EN61547, EN55024, light industry level (surge 4KV), criteria A

LED Chip:



LED COMPONENTS IES LM-80 TESTING RESULTS

Data Set	Case Temp. [T _s]	Ambient Temp. [T _A]	Drive Current [I _r]	Average Lumen Maintenance at 6,000 hours	Average Chromaticity Shift ($\Delta u'v'$) at 6,000 hours	Reported TM-21 Lifetimes
3+	105°C	105°C	200 mA (37V) 400 mA (18V)	98.4% 60000hours=84%	0.0008	L90(10k) > 60,500 hrs L80(10k) > 60,500 hrs L70(10k) > 60,500 hrs
4+	55°C	55°C	375 mA (37V) 750 mA (18V)	97.7%	0.0006	L90(10k) > 60,500 hrs L80(10k) > 60,500 hrs L70(10k) > 60,500 hrs
5+	85°C	85°C	375 mA (37V) 750 mA (18V)	97.6%	0.0007	L90(9k) > 54,400 hrs L80(9k) > 54,400 hrs L70(9k) > 54,400 hrs

Material:

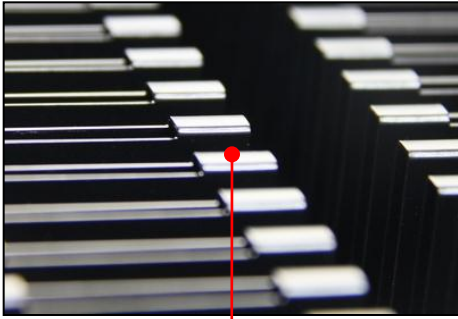

Aluminium alloy heatsink
With electrophoresis treatment

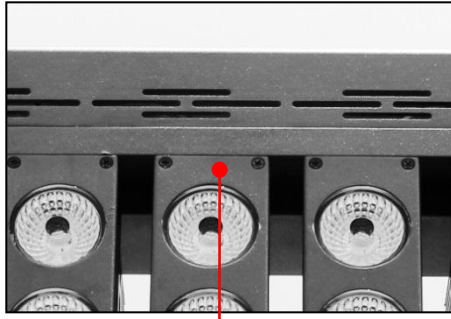

Aluminium alloy housing
With electrostatic spraying



Stainless steel SUS304
Fixed Handle
With electrophoresis treatment

Heat Dissipation Structure:

The heat radiator area of the LED floodlight is the biggest in the high-power LED industry at present

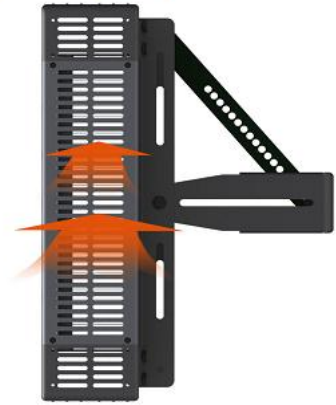
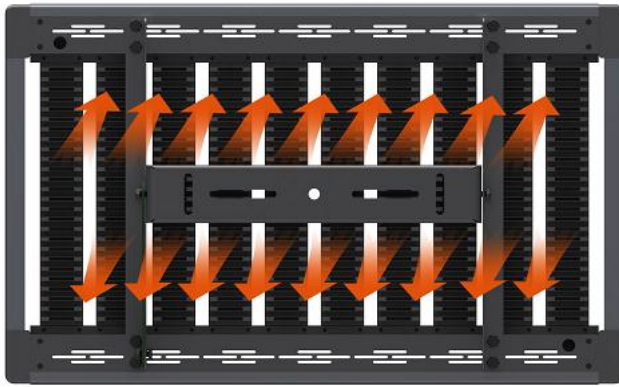

Driver inside with ventilation design, protect it from the damage of sunshine

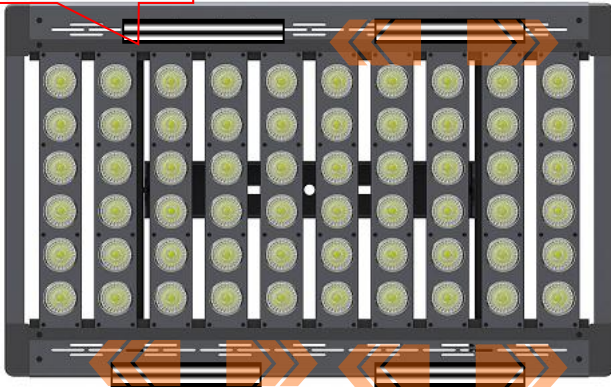

Specification

Main Parameters:

Input Voltage	90-305 VAC, 50/60 Hz
INRUSH CURRENT(Typ)	COLD START 150A(twidth=570 μ s measured at 50%Ipeak)at 230VAC
LEAKAGE CURRENT	<0.75mA/277VAC
POWER FACTOR(Typ.)	PF>0.98/115VAC, PF>0.95/230VAC at full lead
LED Light Source	CREE X1amp
LED Qty	48PCS
LED Power	400W
Total System Power	423W
Power supply	TaiWan MeanWell
Driver Qty	2PCS
LED Luminous Efficiency	150lm/W
LED Initial Luminous Flux	60000Lm
Illuminance Uniformity	>0.8
Color Temperature	2700K,3000K,3500K,4000K,5000K,5700K,6500K
Color Rendering Index	80+/90+
Light Distribution	Asymmetric / Rectangular
Beam Angle	10° /24° /38° /60° /90° 120°
LED Junction Temperature	$\leq 70^{\circ}\text{C}$ (@ Ta=25 $^{\circ}\text{C}$)
Working Temperature	-40 $^{\circ}\text{C}$ ~ +65 $^{\circ}\text{C}$
Storage Temperature	-40 $^{\circ}\text{C}$ ~ +65 $^{\circ}\text{C}$ (Best 25 $^{\circ}\text{C}$)
IP Rating	IP67
Net weight	18Kg
Life-span	>80,000H
Shell Color	Black/Silver/Grey

LumCAT: GL-FL-400W
 Luminaire: LED Flood Light
 Report No: N/A
 Test No: N/A
 LampCAT:
 Lamp flux(lm): 1380.4
 Number of Lamps: 48
 Length(mm): 520
 Phm Type: C

Voltage(V): 120.13
 Current(A): 3.636
 Power (W): 431.5000
 PF: 0.9875
 Ballast type:
 Width(mm): 310
 Height(mm): 21

Photometric Results

Lumens(lm): 66259.31
 Efficiency(%): 100.00%
 Lumens(lm)/Power(W): 153.56
 Central intensity(cd): 130571.400
 Maximum intensity(cd): 133053.800
 Angle of maximum intensity: C=337.5 γ=5.0

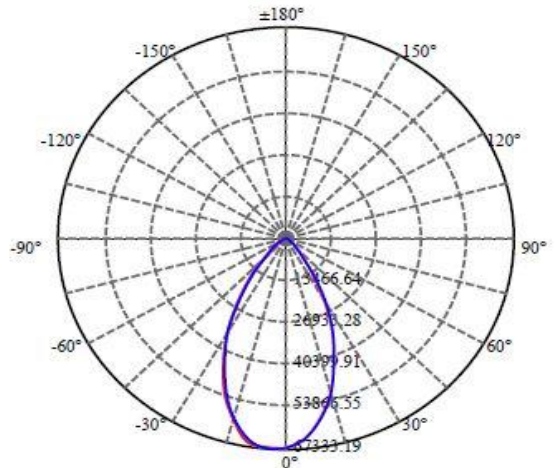
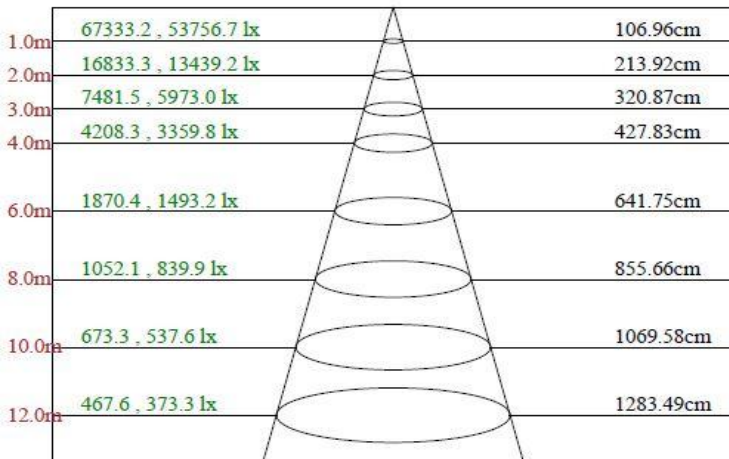
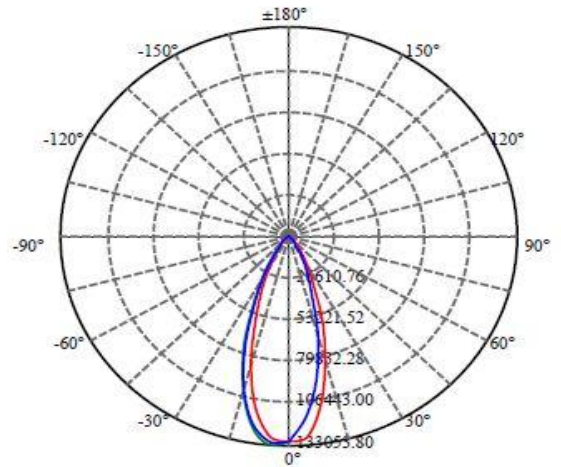
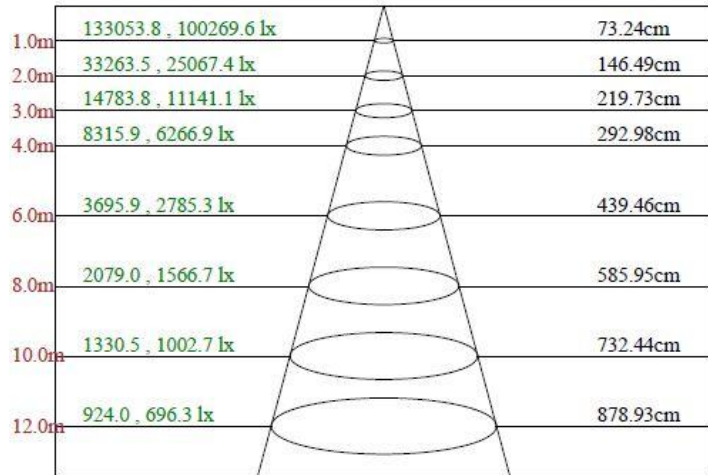

Max , Ave Beam angle of C247.5plane56.09



For detail, please check 400W IES files

Beam Angle

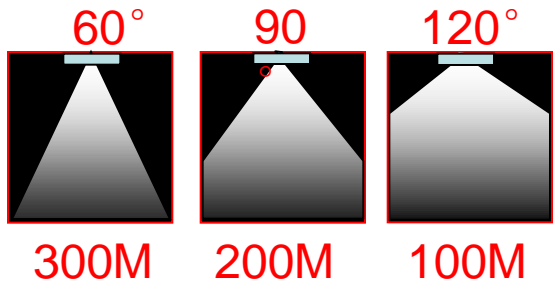
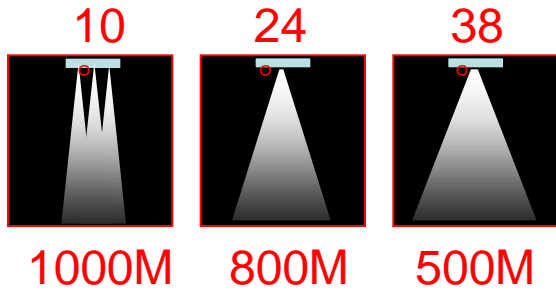

Multi Angle Applications

Two Angle Showing

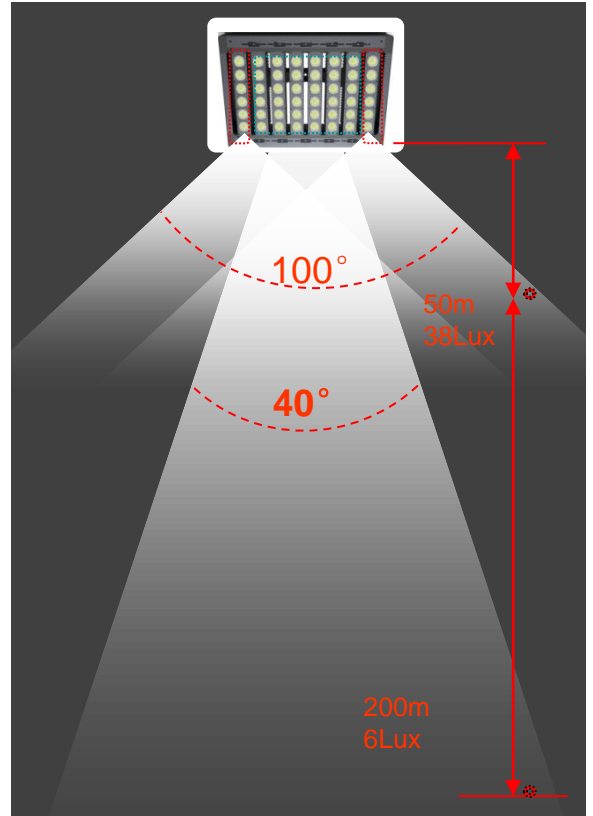

Wiring Diagram

- Black—Neutral
- White—Line
- Green—Ground

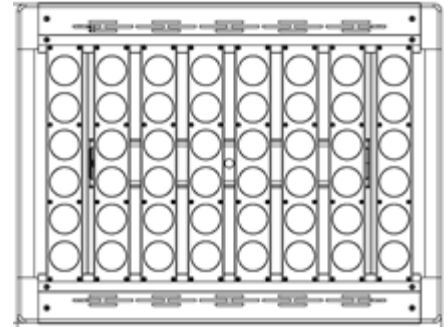
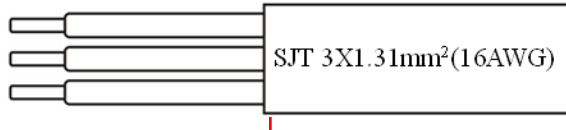

Triphase Cable

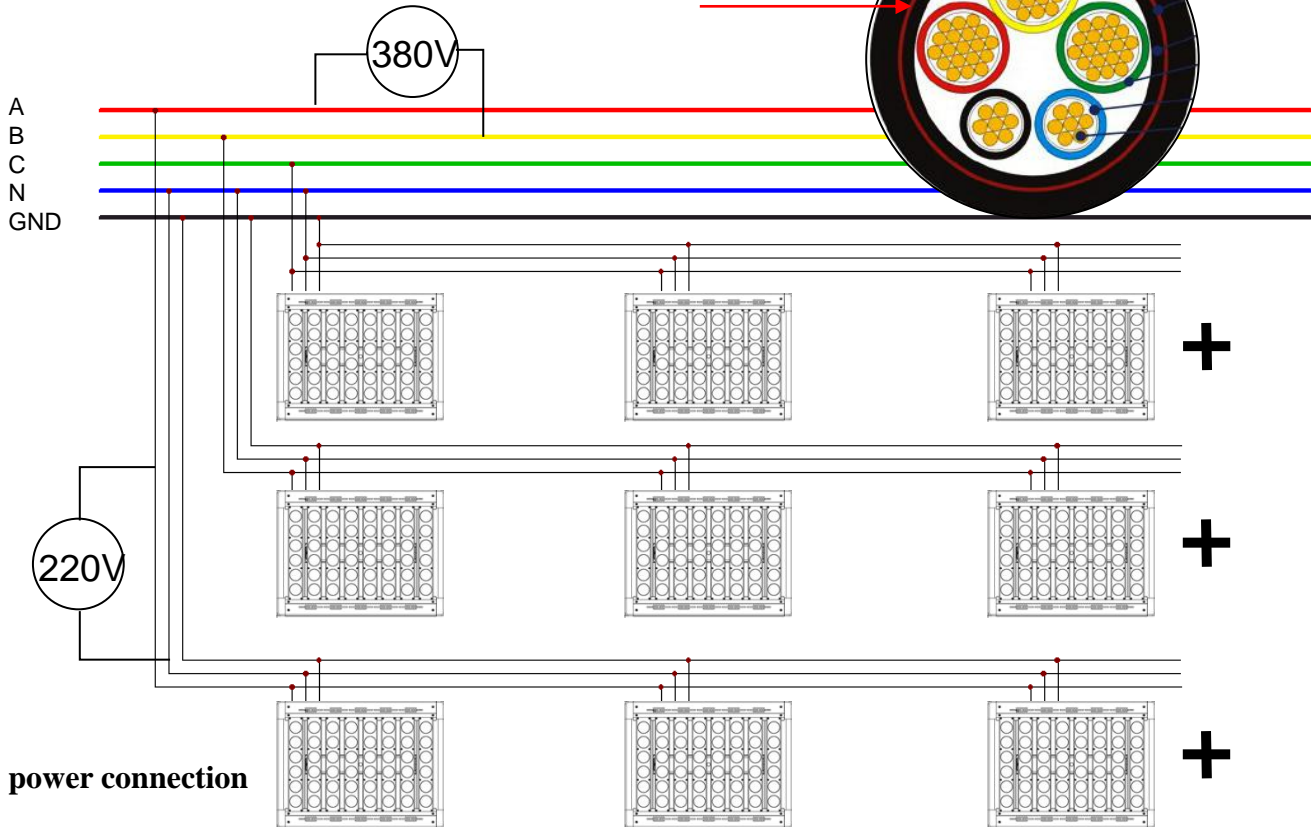
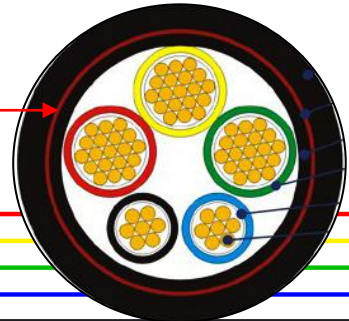

High power connection

Installation Instructions

Through the screw, choose and adjust the angle of the bracket you need before installaing

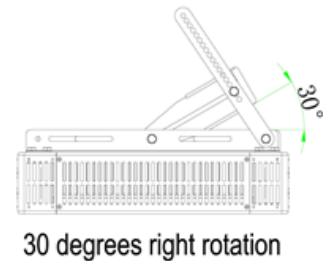
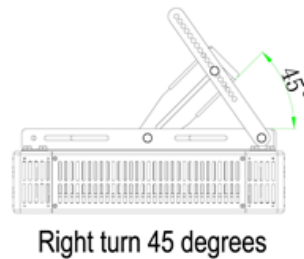
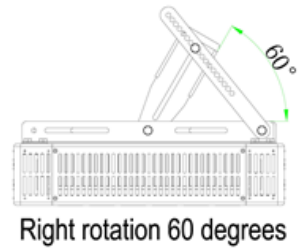
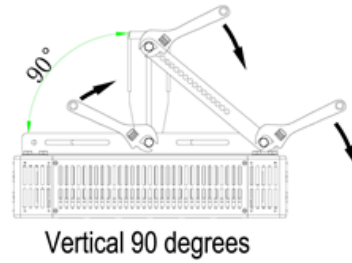
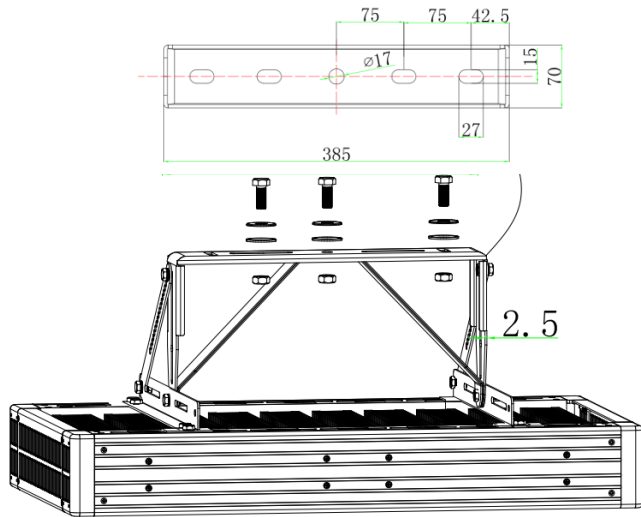

Applications

Applied in large sports field lighting, football, basketball, golf and tennis court, racetrack, badminton, roads, high-rise buildings, tower lights, etc. Can also be applied in large square, airport, commercial building, construction engineering, farm, amusement parks, parking lots, harbor, industrial buildings, and other special lighting environment.

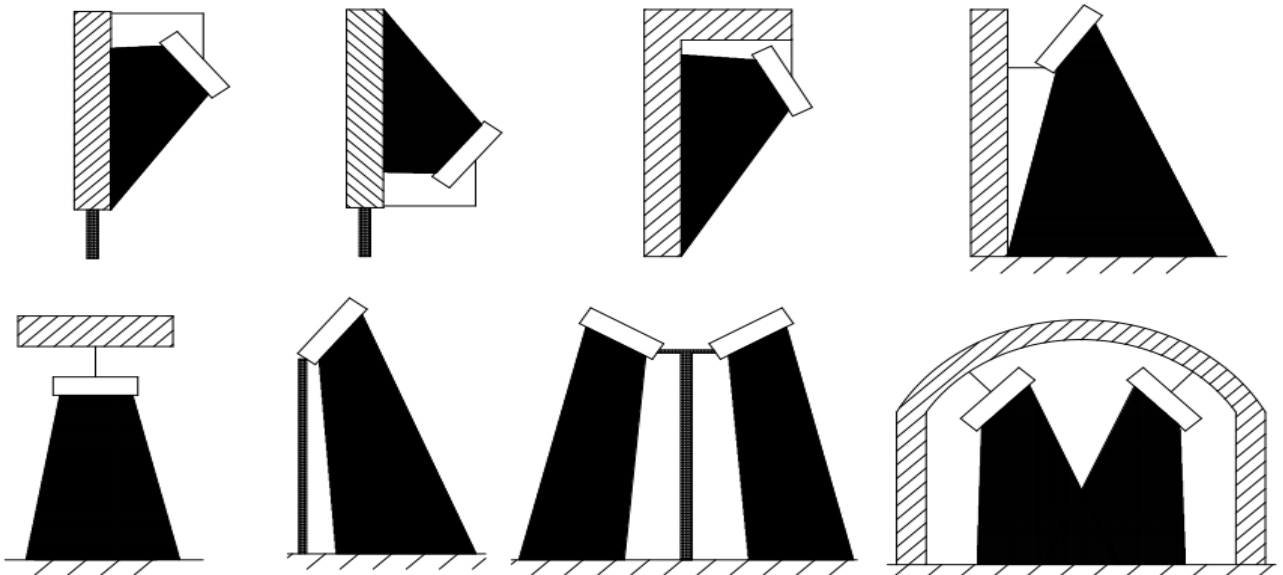

Maintenance / Repairing Instructions:

1. Make sure the power has been turned off before maintenance or repairing.
2. Clean the LED Lens regularly to maintain high transmission of light.
3. Clean up the dust from the lens and heat sink regularly to keep sound heat dispersion.
4. Be careful not to use corrosive solution for cleaning, preferably with a wet cloth.
5. When install or replace power supply, directly open the back cover with a screwdriver, then remove the power supply. On DC power output, the red cable corresponds to the positive power polarity, and black corresponds to the negative.
Pay attention do not reverse the positive and the negative in any circumstance.

Product Dimension-(mm)

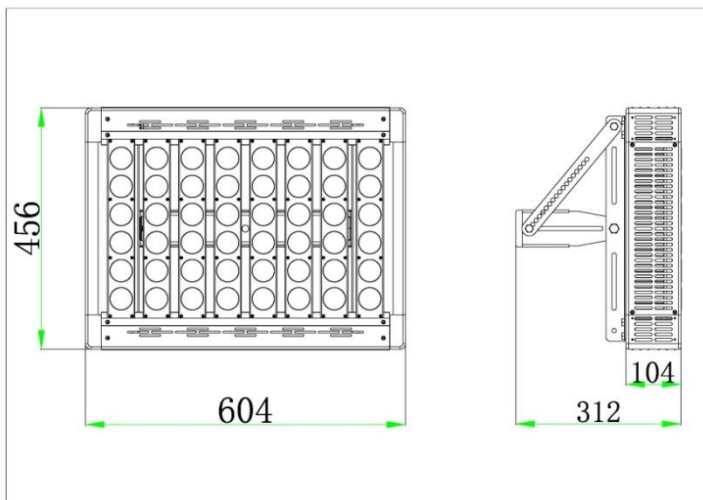

Free-inspection Export Wooden Packing



Packing Size(L*W*H) /1unit	680*530*280mm
N.W.	18Kg
G.W.	27Kg