

PROJECT NAME	
CATALOG NUMBER	
NOTES	
FIXTURE TYPE	

## DESCRIPTION

Ledsion split LED Commercial Downlight series have been optimized to the third generation. The innovative separable design of junction box and housing makes it more flexible, With 70° beam angle, the 6" split commercial downlight can fulfill a wide range of lighting needs. Easy-fit installation comes from adjustable spring-action housing clips. It is designed and engineered for recessed applications, which is suitable for commercial and public places and elegantly decorates the ambience, such as shopping mall, hospital, airport, hotel lobby, etc.

## PERFORMANCE SUMMARY

Model	LS-6C-10W	LS-6C-15W	CP6-D20W-XXX
Efficacy	75LPW	83LPW	82LPW
Rated Power	10W	15W	20W
Delivered light output	750lm	1245lm	1640lm
Input Current	0.1A	0.15A	0.2A
Input Voltage	120-347V AC		
CRI	Ra>80		
CCT Options	3000K, 3500K, 4000K, 5000K		
THD	<20%		
PF	>0.9		
Standard Warranty	5 Years		
Standard Lifetime	Designed minimum 50,000 hours		
Mounting	Recessed		
Temperature Rating	Designed to operate in temperatures 45°C and below room side and plenum side.		
Dimming Type	0-10V dimming		
Recommended Dimmers	DVTV(LUTRON),IP710(LEVITON)		
UL Listed	YES	YES	YES
Energy Star Listed	YES	YES	YES
LM79 Report	YES	YES	YES
Damp Rated	YES	YES	YES

## Split 6" Recessed LED Commercial Downlights



### Dimension:

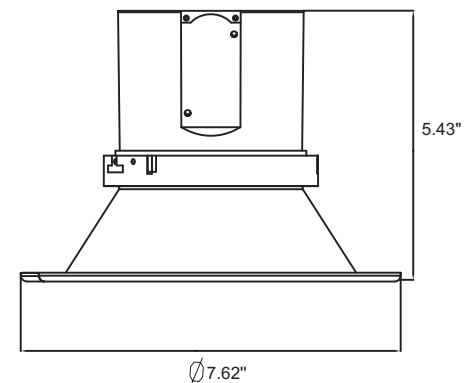

## ORDER INFORMATION

Category	Size	Dimming	Wattage	CCT(XX)	CRI(X)
CP=Commercial Premium Downlight	6=6inch	0-10V Dimming	10W=10W 15W=15W 20W=20W	30=3000K 35=3500K 40=4000K 50=5000K	E=80 CRI



**SPECTRAL POWER DISTRIBUTION & CHROMATICITY DIAGRAM**

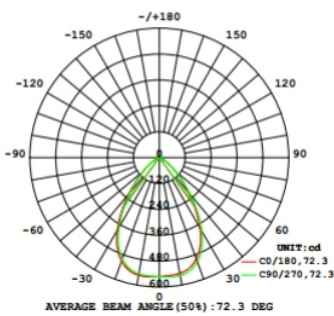
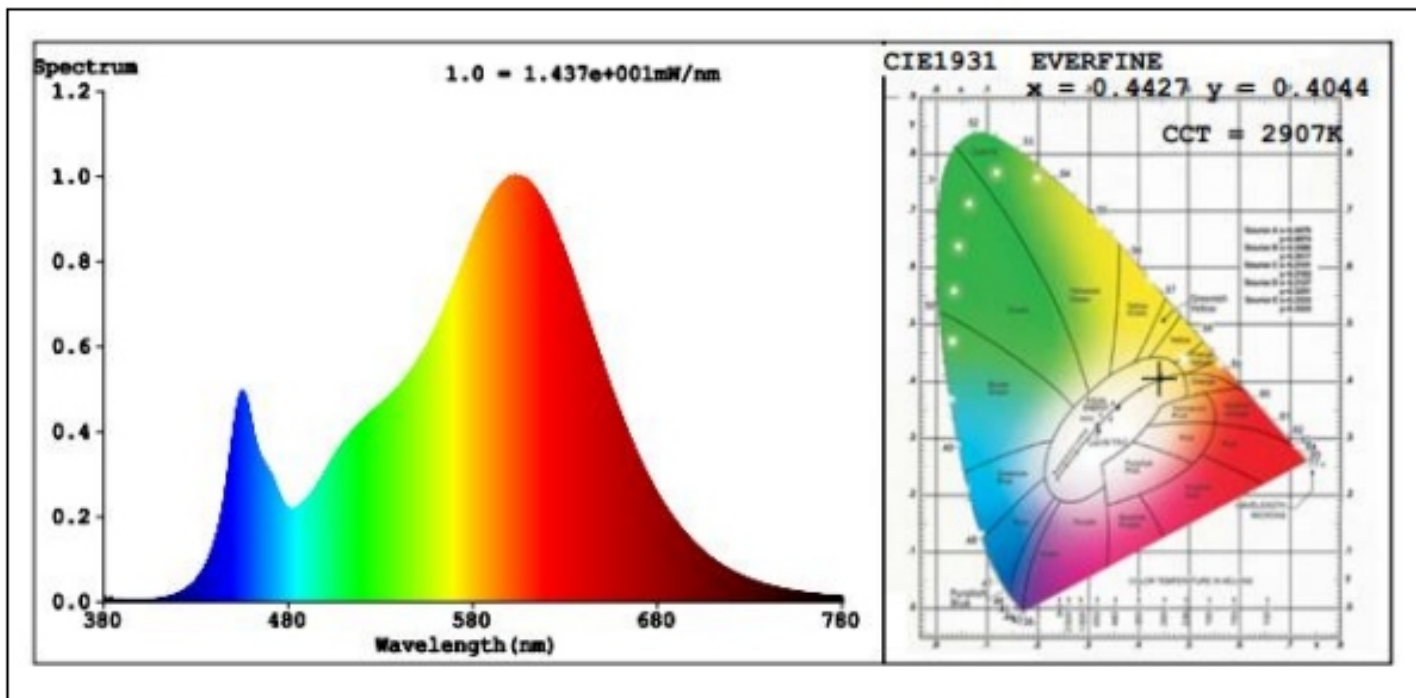

Zonal Lumen Summary		
Zone	Lumens	%Luminaire
0-30	410.0	53%
0-40	549.9	76.9%
0-60	760.8	98.3%
60-90	13.1	1.7%
70-100	1.7	0.2%
90-120	0	0%
0-90	773.9	100%
90-180	0.0	0%
0-180	774.0	100%

Lumens Per Zone					
Zone	Lumens	% Total	Zone	Lumens	% Total
0-10	52.6	6.8%	90-100	0	0%
10-20	150.6	19.5%	100-110	0	0%
20-30	206.8	26.7%	110-120	0	0%
30-40	184.9	23.9%	120-130	0.0	0%
40-50	114.3	14.8%	130-140	0.0	0%
50-60	51.6	6.7%	140-150	0.0	0%
60-70	11.5	1.5%	150-160	0.0	0%
70-80	1.5	0.2%	160-170	0.0	0%
80-90	0.2	0.0%	170-180	0.0	0%

UNIT: cd

Y (DEG)	C (DEG)															
	0	22.5	45	67.5	90	112.5	135	157.5	180	202.5	225	247.5	270	292.5	315	337.5
0	551	551	551	551	551	551	551	551	551	551	551	551	551	551	551	551
5	549	551	553	554	554	554	555	555	555	555	554	552	550	548	547	547
10	544	550	553	555	555	553	553	553	554	555	554	552	547	541	537	539
15	531	538	542	544	543	541	540	540	542	543	542	539	533	525	520	523
20	500	507	511	514	514	512	510	510	511	511	510	507	501	492	488	492
25	448	455	459	463	464	463	461	460	461	459	456	453	447	440	438	441
30	375	381	386	390	393	393	391	389	389	386	382	377	373	368	366	370
35	291	297	303	306	308	307	306	304	305	302	298	292	288	284	283	287
40	210	216	221	224	223	222	221	219	221	220	217	212	207	203	203	206
45	144	149	151	152	152	151	149	149	150	149	148	145	141	138	138	141
50	93.6	95.8	96.9	97.4	97.4	96.8	96.1	95.4	96.4	95.2	93.8	92.5	91.1	89.7	89.9	92.0
55	56.7	57.7	58.2	58.7	58.9	58.9	58.5	57.7	57.5	56.5	55.3	54.5	54.2	54.1	54.8	56.1
60	28.0	28.4	28.7	29.1	29.5	29.7	29.5	28.7	28.4	27.6	26.8	26.4	26.5	26.8	27.4	28.0
65	8.96	8.99	9.05	9.22	9.65	9.89	10.1	9.72	9.40	8.74	8.15	7.82	7.96	8.26	8.82	9.12
70	2.88	2.83	2.84	2.90	3.02	3.17	3.25	3.18	3.06	2.85	2.71	2.66	2.70	2.80	2.93	2.98
75	1.23	1.20	1.21	1.24	1.29	1.35	1.38	1.36	1.31	1.23	1.18	1.16	1.18	1.22	1.26	1.27
80	0.47	0.46	0.46	0.47	0.50	0.53	0.54	0.54	0.52	0.48	0.46	0.45	0.45	0.47	0.49	0.49
85	0.12	0.12	0.12	0.13	0.14	0.14	0.15	0.15	0.14	0.13	0.12	0.12	0.12	0.13	0.14	0.13



**SPECTRAL POWER DISTRIBUTION & CHROMATICITY DIAGRAM**

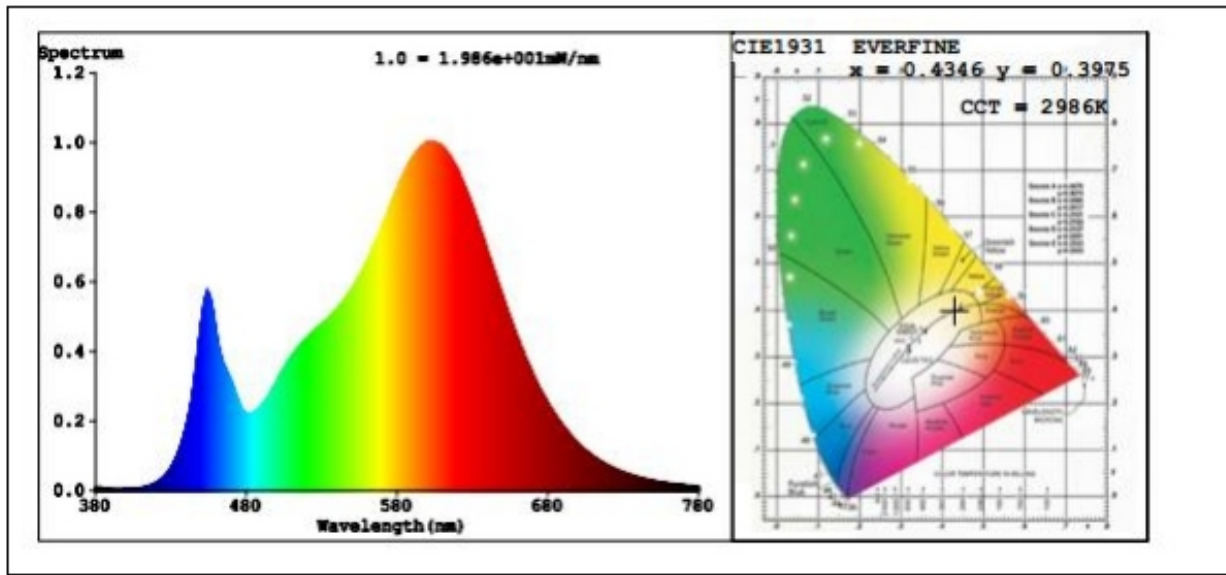

**ZONAL LUMEN TABULATION**

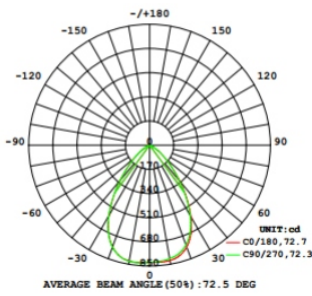

Zonal Lumen Summary		
Zone	Lumens	%Luminaire
0-30	615.5	53%
0-40	893.6	76.9%
0-60	1,141.8	98.3%
60-90	19.8	1.7%
70-100	2.5	0.2%
90-120	0	0%
0-90	1,161.6	100%
90-180	0.0	0%
0-180	1,161.7	100%

Lumens Per Zone					
Zone	Lumens	% Total	Zone	Lumens	% Total
0-10	78.7	6.8%	90-100	0	0%
10-20	225.8	19.4%	100-110	0	0%
20-30	311.0	26.8%	110-120	0	0%
30-40	278.1	23.9%	120-130	0.0	0%
40-50	171.1	14.7%	130-140	0.0	0%
50-60	77.2	6.6%	140-150	0.0	0%
60-70	17.3	1.5%	150-160	0.0	0%
70-80	2.2	0.2%	160-170	0.0	0%
80-90	0.3	0.0%	170-180	0.0	0%

UNIT: cd

C (DEG)	0	22.5	45	67.5	90	112.5	135	157.5	180	202.5	225	247.5	270	292.5	315	337.5
0	825	825	825	825	825	825	825	825	825	825	825	825	825	825	825	825
5	825	822	820	819	819	821	823	826	828	829	830	830	830	830	829	827
10	824	819	815	811	810	814	819	824	827	828	829	828	828	829	830	828
15	806	802	797	792	790	795	801	806	809	811	811	810	810	812	814	812
20	762	759	754	749	746	750	755	758	761	762	762	762	763	767	769	768
25	688	686	682	677	674	676	678	680	683	683	683	684	686	690	693	693
30	580	580	577	572	569	568	569	569	572	572	573	573	576	580	584	584
35	454	454	452	448	444	442	442	441	444	444	444	444	447	451	454	456
40	330	330	328	325	321	319	318	318	321	320	319	318	321	324	327	331
45	224	226	225	222	219	217	216	216	217	216	215	214	215	218	221	224
50	144	146	147	145	142	141	140	139	140	139	138	137	137	139	142	144
55	87.2	89.1	89.6	88.6	87.1	85.7	84.3	83.0	83.1	82.3	81.2	80.4	80.9	82.3	84.1	86.2
60	44.3	45.9	46.4	45.9	44.8	43.4	42.0	40.8	40.7	40.1	39.2	38.6	39.0	40.0	41.3	43.0
65	14.9	16.3	16.9	16.5	15.4	14.0	12.9	12.2	12.3	12.3	12.2	11.9	11.8	12.1	12.6	15.3
70	4.77	5.05	5.15	4.94	4.60	4.31	4.13	4.06	4.16	4.24	4.25	4.16	4.10	4.14	4.27	4.52
75	2.04	2.15	2.17	2.08	1.94	1.81	1.73	1.71	1.77	1.80	1.82	1.79	1.76	1.79	1.87	1.97
80	0.81	0.86	0.86	0.82	0.74	0.67	0.64	0.63	0.66	0.68	0.69	0.69	0.67	0.68	0.72	0.77
85	0.23	0.25	0.25	0.23	0.20	0.18	0.17	0.16	0.17	0.17	0.17	0.17	0.17	0.18	0.20	0.22



**SPECTRAL POWER DISTRIBUTION & CHROMATICITY DIAGRAM**

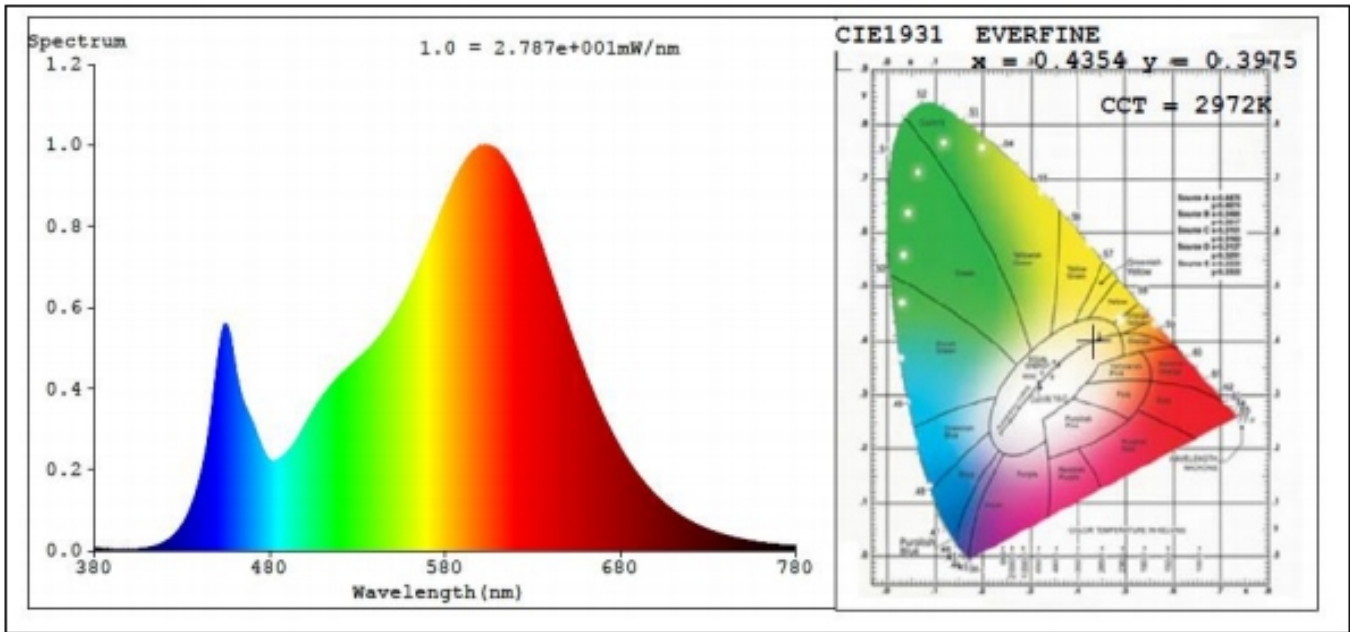

**ZONAL LUMEN TABULATION**

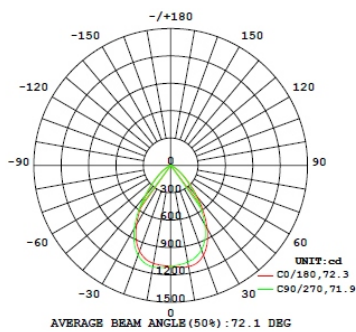

Zonal Lumen Summary		
Zone	Lumens	%Luminaire
0-30	828.7	53.1%
0-40	1,203.2	77.2%
0-60	1,532.7	98.3%
60-90	26.4	1.7%
70-100	3.4	0.2%
90-120	0	0%
0-90	1,599.1	100%
90-180	0.0	0%
0-180	1,599.2	100%

Lumens Per Zone					
Zone	Lumens	% Total	Zone	Lumens	% Total
0-10	105.8	6.8%	90-100	0	0%
10-20	303.7	19.5%	100-110	0	0%
20-30	419.1	26.7%	110-120	0	0%
30-40	374.5	24%	120-130	0.0	0%
40-50	227.2	14.6%	130-140	0.0	0%
50-60	102.2	6.6%	140-150	0.0	0%
60-70	23.0	1.5%	150-160	0.0	0%
70-80	3.0	0.2%	160-170	0.0	0%
80-90	0.4	0.0%	170-180	0.0	0%

UNIT: cd

C (DEG)	0	22.5	45	67.5	90	112.5	135	157.5	180	202.5	225	247.5	270	292.5	315	337.5
0	1107	1107	1107	1107	1107	1107	1107	1107	1107	1107	1107	1107	1107	1107	1107	1107
5	1120	1115	1106	1098	1094	1090	1091	1095	1100	1106	1113	1118	1125	1125	1127	1124
10	1125	1116	1104	1087	1076	1071	1075	1084	1091	1103	1115	1123	1129	1133	1135	1135
15	1109	1097	1083	1061	1044	1037	1045	1053	1063	1077	1091	1101	1107	1113	1120	1118
20	1047	1037	1023	1003	985	978	982	988	999	1013	1030	1041	1046	1054	1062	1060
25	946	936	923	906	890	882	882	886	896	909	925	937	945	952	961	959
30	800	791	779	763	748	739	738	741	751	762	777	790	798	807	815	814
35	626	618	606	590	576	568	568	573	583	292	603	614	623	632	639	639
40	454	446	434	419	409	403	404	409	420	428	433	438	445	452	459	462
45	305	301	292	282	275	271	274	278	285	288	291	292	295	300	306	310
50	194	192	189	184	179	178	180	182	186	187	188	187	188	191	196	199
55	115	114	113	111	110	109	110	111	113	112	111	110	110	112	115	117
60	56.4	56.4	56.5	56.3	56.0	56.1	56.6	56.8	57.0	55.8	54.5	53.4	53.3	54.1	56.1	57.4
65	18.4	18.5	18.4	18.3	18.5	18.8	19.1	19.4	21.9	20.9	19.1	18.3	18.1	18.5	19.5	20.9
70	6.53	6.43	5.96	5.91	5.93	6.07	6.55	6.69	6.36	5.96	5.53	5.30	5.30	5.54	5.87	6.21
75	2.69	2.63	2.58	2.58	2.60	2.66	2.71	2.74	2.71	2.53	2.35	2.25	2.26	2.36	2.54	2.68
80	1.08	1.06	1.03	1.01	1.01	1.03	1.06	1.08	1.06	0.97	0.88	0.84	0.85	0.91	0.99	1.07
85	0.32	0.31	0.30	0.27	0.28	0.29	0.30	0.30	0.30	0.26	0.23	0.22	0.22	0.25	0.28	0.31

