

LED Post Top Bulb

LED post top bulb is tailored to replace MH HPS HID CFL lamp etc.
for post top/acorn/lantern lighting fixtures etc.

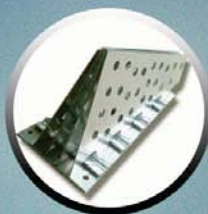

Aluminum fins heat sink
93% purity



Epistar 2835 SMD Tech
120 lm/w



Sunon brand Fan
ball bearing

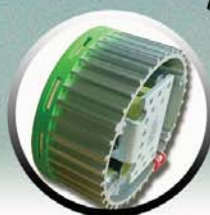

IP65 driver
Aluminum enclosed

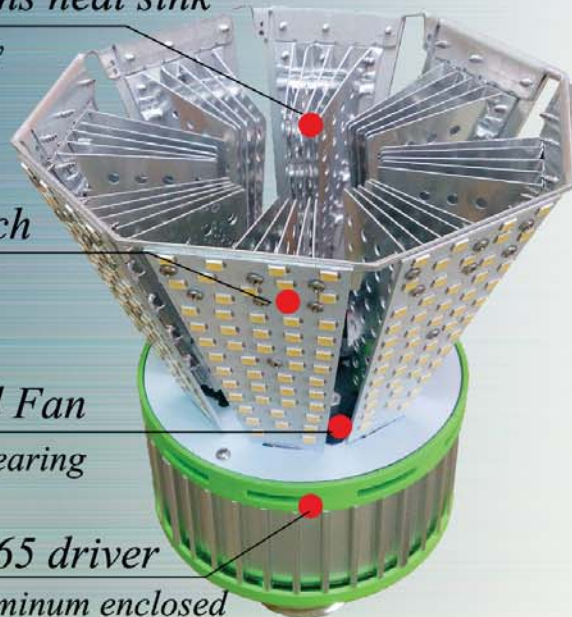

Dimension:

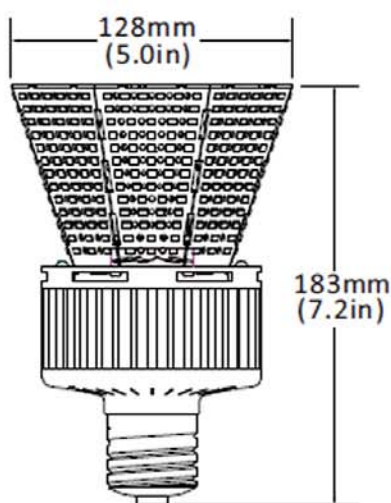

30W-60W

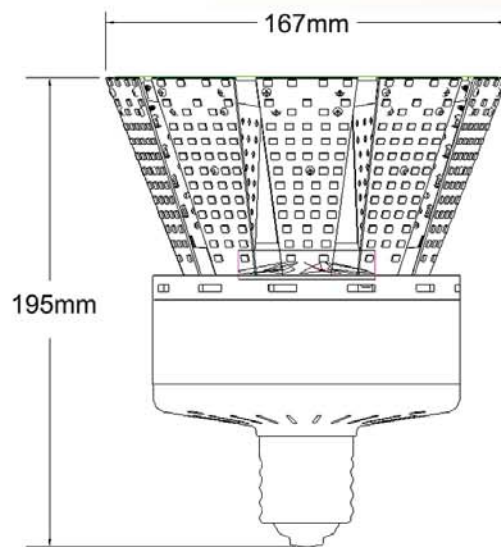
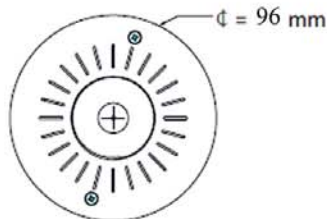

80W

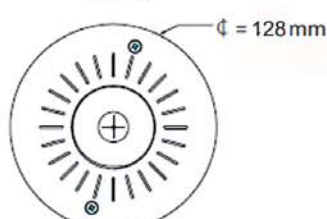

LED Post Top Bulb

Specification:

Item No.	Rated Watt	Input Volt	Power Factor	CRI	Replacement	Lumens
YL-30W8S-E39	30W	100-277VAC	PF>0.95	Ra>80	100W MH HPS HID	3800LM
YL-40W8S-E39	40W	100-277VAC	PF>0.95	Ra>80	120W MH HPS HID	5000LM
YL-50W8S-E39	50W	100-277VAC	PF>0.95	Ra>80	150W MH HPS HID	6200LM
YL-60W8S-E39	60W	100-277VAC	PF>0.95	Ra>80	175W MH HPS HID	7400LM
YL-80W10S-E39	80W	100-277VAC	PF>0.95	Ra>80	250W MH HPS HID	10400LM

- Color temperature: 2700K,3000K,4000K,5000K,5700K etc.
- Life time: over 50,000 hours
- Insect-proof, moisture-proof, with 4KV surge protection.
- Enclosed fixture applicable.



Applications:

This LED bulb can be applied for all different post top and acorn fixtures to replace MH HPS HID lamp up to 250w.(including but not limited to)



Please remove any ballast or capacitor parts before doing the retrofiting.