

# SIGN STORM™

## LED Sign Tube



**Easy Retrofit**



**Direct AC Power For New Installation**

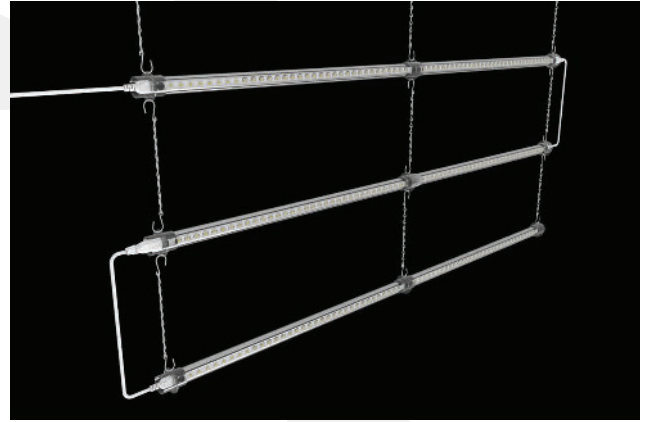

Our new and revolutionary SignStorm Sign tube Offering significant energy-efficiency and lifetime improvements over fluorescent lamps. SignStorm lamps are installed by bypassing existing fluorescent ballasts, and hard-wiring tombstone lamp-holders directly to incoming AC power leads. Dual-ended bypass lamps eliminate the need to replace shunted tombstone lamp-holders in existing fluorescent luminaires. AC power code is also provided for new installation.

### **Extreme Energy savings**

Get comparable light output using Sign Storm with fluorescent lamps. Sign Storm also has a longer useful life compared to fluorescent, reducing maintenance and replacement costs.

### **Quick And Easy Installation**

Our revolutionary technology eliminates the need for an external driver and ballast while still using the existing sockets. Type B, ballast bypass design saves time and fast and easy installation.

### **No Hot Spot**

We've added optical lenses to cover each individual LED chip in the tube, which eliminates hot spots and ensures consistent light distribution across both faces of the sign.

# SIGN STORM™

## LED Sign Tube



### Only Four Sizes

We have solutions for any size sign cabinet. Only four sizes of SIGN STORM are capable of creating practically any size.

### Innovation

Revolutionary design consists of 2 parts that combine to be one tube which can make virtually any size.

### Retrofit & New Installation

Rotatable R17 end cap that swivels, make retrofit easy and AC power code is specially designed for new installation.

### Built To Last

Heavy duty aluminum heatsink ensures the LEDs run cooler for longer. Plastic and aluminum construction ensures less breakage.

## Product Features

- Operating temperature: -20°C to 45°C
- High energy efficiency, long lifespan, 50,000 hour lifetime
- Lockable and Rotatable R17d end cap ensures easy installation and consistent light distribution
- Integral LED driver (non-isolated), eliminates the need for an external driver or ballast
- Up to 125 lumens per watt
- ETL listed
- High Quality and Efficacy Hongli 2835 chips
- This product is IP44 rated, therefore, it is touchproof and resistant to dust
- Universal operation at 120-277Vac 50-60Hz
- Environment friendly with no mercury
- Type B, ballast bypass design offers easy installation and operation
- Direct replacement for fluorescent lamps
- Reduced maintenance and replacement costs
- Available in four different sizes
- Option of making virtually any size by combining two parts of the product in one tube
- Non flicker, optical lens covers eliminate hot spots and ensure consistent light distribution
- Aluminium + PC lamp housing ensures less breakage and good heat dissipation

# SIGN STORM™

## LED Sign Tube

SKU #	Type	Watt	Lumens	CCT	IP	Illumination	Size	Input Voltage	Certifications
152727	Type B/ Double Ended Power	3W	336Lm	6500K	IP44	Single Sided 180°	12"	120V-277V	ETL
152728	Type B/ Double Ended Power	4.5W	507Lm	6500K	IP44	Single Sided 180°	18"	120V-277V	ETL
152729	Type B/ Double Ended Power	7.5W	844Lm	6500K	IP44	Single Sided 180°	30"	120V-277V	ETL
152730	Type B/ Double Ended Power	10.5W	1181Lm	6500K	IP44	Single Sided 180°	42"	120V-277V	ETL
152731	Type B/ Double Ended Power	6W	675Lm	6500K	IP44	Double Sided 360°	12"	120V-277V	ETL
152732	Type B/ Double Ended Power	9W	1012Lm	6500K	IP44	Double Sided 360°	18"	120V-277V	ETL
152733	Type B/ Double Ended Power	15W	1687Lm	6500K	IP44	Double Sided 360°	30"	120V-277V	ETL
152734	Type B/ Double Ended Power	21W	2362Lm	6500K	IP44	Double Sided 360°	42"	120V-277V	ETL

### Correlated Color Temperature (CCT)

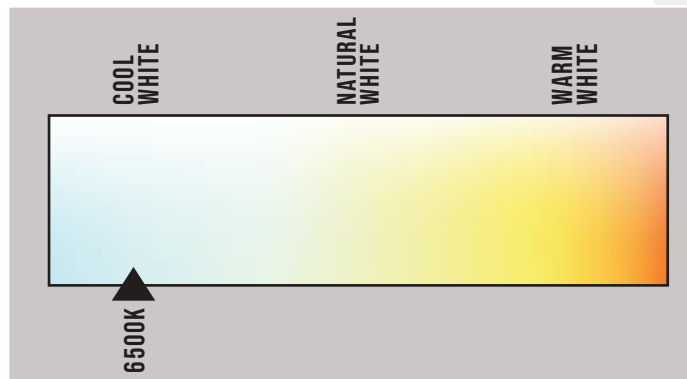





# SIGN STORM™

## LED Sign Tube

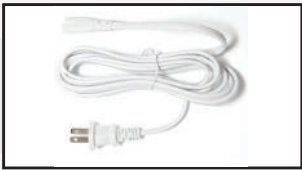

### Components

Component Name	SKU #	Specification	Image
End Cap R17d for Sign Tube (Needed when Use as Tube)	152736	End Cap R17d for Sign Tube (Needed when Use as Tube)	
Transparent Butt Joint	152735	Transparent Butt Joint	
Waterproof	153458	Needed when use as fixture. Length: 39.37"	
Power Cord with plug			
Hanging Chain	152737	12", With "S" hook	



# SIGN STORM™

## LED Sign Tube

### SINGLE ENDED

Target Lamp	SKU #	Size (B/C)	Total Power (180°)	Total Luminous Flux (180°)	Installation
T8 18" R17d	ST812 End Cap R17 152727 + 152736	12"/ 15.82"	3W	375lm	R17d or Power cord
T8 24" R17d	ST818 End Cap R17 152728 + 152736	18"/ 21.82"	4.5W	563lm	R17d or Power cord
T8 30" R17d	ST812 End Cap R17 Transparent Joint 2 x 152727 + 152736 + 152735	24"/ 27.82"	6W	750lm	R17d or Power cord
T8 36" R17d	ST830 End Cap R17 152729 + 152736	30"/ 33.82"	7.5W	938lm	R17d or Power cord
T8 42" R17d	ST818 End Cap R17 Transparent Joint 2 x 152728 + 152736 + 152735	36"/ 39.82"	9W	1125lm	R17d or Power cord
T8 48" R17d	ST842 End Cap R17 152730 + 152736	42"/ 45.82"	10.5W	1313lm	R17d or Power cord
T8 60" R17d	ST812 ST830 End Cap R17 Transparent Joint 2 x 152727 + 152729 + 152736 + 2 x 152735	60"(B)	15W	1875lm	R17d or Power cord
T8 72" R17d	ST812 ST842 End Cap R17 Transparent Joint 2 x 152727 + 152730 + 152736 + 2 x 152735	66"/ 69.82"	16.5W	2063m	R17d or Power cord
T8 84" R17d	ST830 ST818 End Cap R17 Transparent Joint 2 x 152729 + 152728 + 152736 + 2 x 152735	78"/ 81.82"	19.5W	2438lm	R17d or Power cord
T8 96" R17d	ST830 End Cap R17 Transparent Joint 3 x 152729 + 152736 + 2 x 152735	90"/ 93.82"	22.5W	2813lm	R17d or Power cord
T8 108" R17d	ST818 ST842 End Cap R17 Transparent Joint 152728 + 2 x 152730 + 152736 + 2 x 152735	102"/ 105.82"	25.5W	3188lm	R17d or Power cord
T8 120" R17d	ST830 ST842 End Cap R17 Transparent Joint 152729 + 2 x 152730 + 152736 + 2 x 152735	114"/ 117.82"	28.5W	3563lm	R17d or Power cord

# SIGN STORM™

## LED Sign Tube



### DOUBLE ENDED

Target Lamp	SKU #	Size (B/C)	Total Power (360°)	Total Luminous Flux (360°)	Installation
T8 18" R17d	ST812 End Cap R17 152731 + 152736	12"/ 15.82"	6W	750lm	R17d or Power cord
T8 24" R17d	ST818 End Cap R17 152732 + 152736	18"/ 21.82"	9W	1125lm	R17d or Power cord
T8 30" R17d	ST812 End Cap R17 Transparent Joint 2 × 152731 + 152736 + 152735	24"/ 27.82"	12W	1500lm	R17d or Power cord
T8 36" R17d	ST830 End Cap R17 152733 + 152736	30"/ 33.82"	15W	1875lm	R17d or Power cord
T8 42" R17d	ST818 End Cap R17 Transparent Joint 2 × 152732 + 152736 + 152735	36"/ 39.82"	18W	2250lm	R17d or Power cord
T8 48" R17d	ST842 End Cap R17 152734 + 152736	42"/ 45.82"	21W	2625lm	R17d or Power cord
T8 60" R17d	ST812 ST830 End Cap R17 Transparent Joint 2 × 152731 + 152733 + 152736 + 2 × 152735	60"(B)	30W	3750lm	R17d or Power cord
T8 72" R17d	ST812 ST842 End Cap R17 Transparent Joint 2 × 152731 + 152734 + 152736 + 2 × 152735	66"/ 69.82"	33W	4125lm	R17d or Power cord
T8 84" R17d	ST830 ST818 End Cap R17 Transparent Joint 2 × 152733 + 152732 + 152736 + 2 × 152735	78"/ 81.82"	39W	4875lm	R17d or Power cord
T8 96" R17d	ST830 End Cap R17 Transparent Joint 3 × 152733 + 152736 + 2 × 152735	90"/ 93.82"	45W	5625lm	R17d or Power cord
T8 108" R17d	ST818 ST842 End Cap R17 Transparent Joint 152732 + 2 × 152734 + 152736 + 2 × 152735	102"/ 105.82"	51W	6375lm	R17d or Power cord
T8 120" R17d	ST830 ST842 End Cap R17 Transparent Joint 152733 + 2 × 152734 + 152736 + 2 × 152735	114"/ 117.82"	57W	7125lm	R17d or Power cord



# SIGN STORM™

## LED Sign Tube

R17d base adapter connect

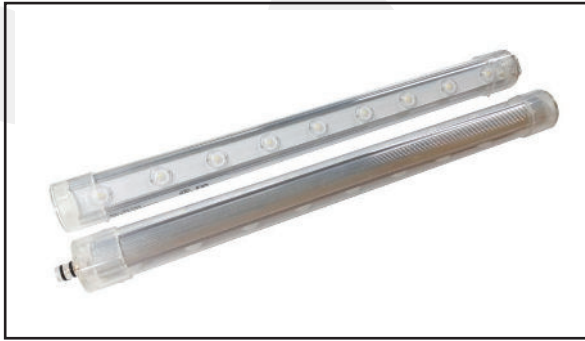
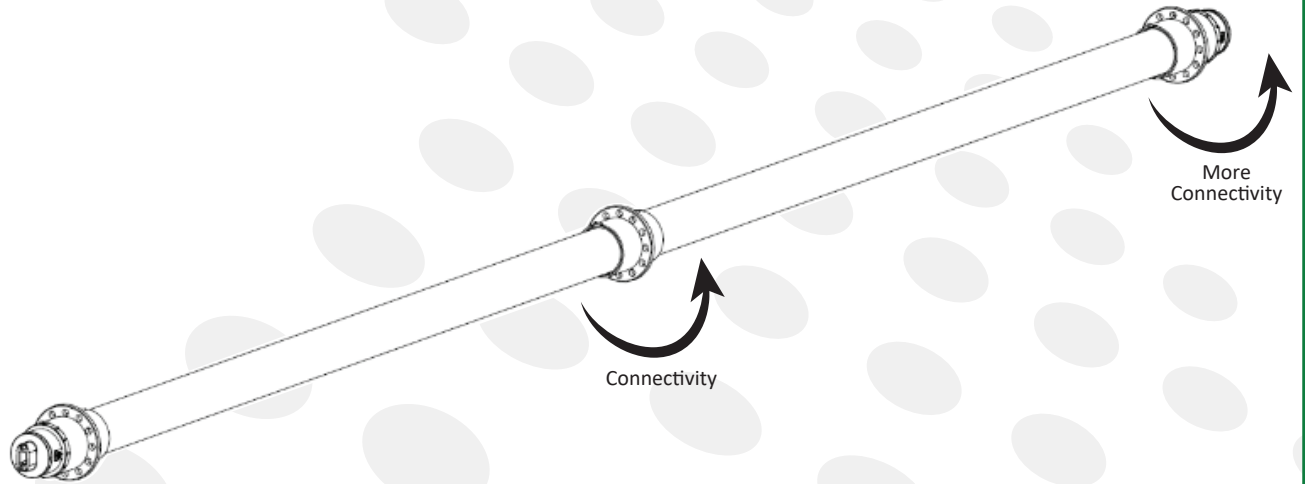

Waterproof power cord connect

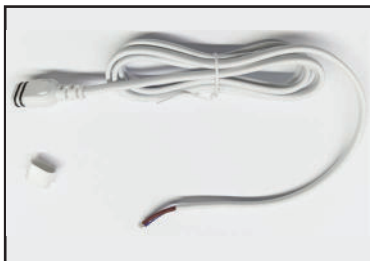

# SIGN STORM™

## LED Sign Tube



SKU # 152727

### Specifications

General Performance	Model #	BLT-ST812-3WD-180-65K
	Watt	3W
	Color Temperature Adj.	6500K
	Lumens	Up to 336LM
	Lumen Efficacy	Up to 112LM/W
	CRI (Ra)	>80
	Diffuser Type	Clear
	Beam Angle	180°
Electrical	Input Voltage	120-277VAC 50/60Hz
	PF	≥0.9
Physical	DLC Type	Type B
	Power Ends	2 Power Ends
	Size	12"
	Lens	Clear Cover
Qualification	LED Brand	Hongli
	LED Type	SMD 2835
	LED Qty	9 Pcs
	Housing	PC + Aluminum
	Driver	Beyond LED Technology
	IP Rating	IP44
Warranty Time	5 Years	

# SIGN STORM™

## LED Sign Tube

SKU # 152728

### Specifications

General Performance	Model #	BLT-ST818-4.5WD-180-65K
	Watt	4.5W
	Color Temperature Adj.	6500K
	Lumens	Up to 507LM
	Lumen Efficacy	Up to 113LM/W
	CRI (Ra)	>80
	Diffuser Type	Clear
	Beam Angle	180°
Electrical	Input Voltage	120-277VAC 50/60Hz
	PF	≥0.9
Physical	DLC Type	Type B
	Power Ends	2 Power Ends
	Size	12"
	Lens	Clear Cover
Qualification	LED Brand	Hongli
	LED Type	SMD 2835
	LED Qty	12 Pcs
	Housing	PC + Aluminum
	Driver	Beyond LED Technology
	IP Rating	IP44
Warranty Time	5 Years	

# SIGN STORM™

## LED Sign Tube



SKU # 152729

### Specifications

General Performance	Model #	BLT-ST830-7.5WD-180-65K
	Watt	7.5W
	Color Temperature Adj.	6500K
	Lumens	Up to 844LM
	Lumen Efficacy	Up to 112LM/W
	CRI (Ra)	>80
	Diffuser Type	Clear
	Beam Angle	180°
Electrical	Input Voltage	120-277VAC 50/60Hz
	PF	≥0.9
Physical	DLC Type	Type B
	Power Ends	2 Power Ends
	Size	30"
	Lens	Clear Cover
Qualification	LED Brand	Hongli
	LED Type	SMD 2835
	LED Qty	22 Pcs
	Housing	PC + Aluminum
	Driver	Beyond LED Technology
	IP Rating	IP44
Warranty Time	5 Years	

# SIGN STORM™

## LED Sign Tube

SKU # 152730

### Specifications

General Performance	Model #	BLT-ST842-10.5WD-180-65K
	Watt	10.5W
	Color Temperature Adj.	6500K
	Lumens	Up to 1181LM
	Lumen Efficacy	Up to 112LM/W
	CRI (Ra)	>80
	Diffuser Type	Clear
	Beam Angle	180°
Electrical	Input Voltage	120-277VAC 50/60Hz
	PF	≥0.9
Physical	DLC Type	Type B
	Power Ends	2 Power Ends
	Size	42"
	Lens	Clear Cover
Qualification	LED Brand	Hongli
	LED Type	SMD 2835
	LED Qty	30 Pcs
	Housing	PC + Aluminum
	Driver	Beyond LED Technology
	IP Rating	IP44
Warranty Time	5 Years	

# SIGN STORM™

## LED Sign Tube



**SKU # 152731**

### Specifications

General Performance	Model #	BLT-ST812-6WD-360-65K
	Watt	6W
	Color Temperature Adj.	6500K
	Lumens	Up to 675LM
	Lumen Efficacy	Up to 112LM/W
	CRI (Ra)	>80
	Diffuser Type	Clear
	Beam Angle	360°
Electrical	Input Voltage	120-277VAC 50/60Hz
	PF	≥0.9
Physical	DLC Type	Type B
	Power Ends	2 Power Ends
	Size	12"
	Lens	Clear Cover
Qualification	LED Brand	Hongli
	LED Type	SMD 2835
	LED Qty	18 Pcs
	Housing	PC + Aluminum
	Driver	Beyond LED Technology
	IP Rating	IP44
Warranty Time	5 Years	

LED SIGNAGE LIGHTS

# SIGN STORM™

## LED Sign Tube

SKU # 152732

### Specifications

General Performance	Model #	BLT-ST818-9WD-360-65K
	Watt	9W
	Color Temperature Adj.	6500K
	Lumens	Up to 1012LM
	Lumen Efficacy	Up to 112LM/W
	CRI (Ra)	>80
	Diffuser Type	Clear
	Beam Angle	360°
Electrical	Input Voltage	120-277VAC 50/60Hz
	PF	≥0.9
Physical	DLC Type	Type B
	Power Ends	2 Power Ends
	Size	18"
	Lens	Clear Cover
Qualification	LED Brand	Hongli
	LED Type	SMD 2835
	LED Qty	24 Pcs
	Housing	PC + Aluminum
	Driver	Beyond LED Technology
	IP Rating	IP44
Warranty Time	5 Years	

# SIGN STORM™

## LED Sign Tube



SKU # 152733

### Specifications

General Performance	Model #	BLT-ST830-15WD-360-65K
	Watt	15W
	Color Temperature Adj.	6500K
	Lumens	Up to 1687LM
	Lumen Efficacy	Up to 112LM/W
	CRI (Ra)	>80
	Diffuser Type	Clear
	Beam Angle	360°
Electrical	Input Voltage	120-277VAC 50/60Hz
	PF	≥0.9
Physical	DLC Type	Type B
	Power Ends	2 Power Ends
	Size	30"
	Lens	Clear Cover
Qualification	LED Brand	Hongli
	LED Type	SMD 2835
	LED Qty	44 Pcs
	Housing	PC + Aluminum
	Driver	Beyond LED Technology
	IP Rating	IP44
Warranty Time	5 Years	

# SIGN STORM™

## LED Sign Tube

SKU # 152734

### Specifications

General Performance	Model #	BLT-ST842-21WD-360-65K
	Watt	21W
	Color Temperature Adj.	6500K
	Lumens	Up to 2362LM
	Lumen Efficacy	Up to 112LM/W
	CRI (Ra)	>80
	Diffuser Type	Clear
	Beam Angle	360°
Electrical	Input Voltage	120-277VAC 50/60Hz
	PF	≥0.9
Physical	DLC Type	Type B
	Power Ends	2 Power Ends
	Size	42"
	Lens	Clear Cover
Qualification	LED Brand	Hongli
	LED Type	SMD 2835
	LED Qty	60 Pcs
	Housing	PC + Aluminum
	Driver	Beyond LED Technology
	IP Rating	IP44
Warranty Time	5 Years	

# SIGN STORM™

## LED Sign Tube



### Dimensions

The units covered by this report were intended to retrofit surface mount with diffuser for these models, Type IC or non-IC recessed mount listed fluorescent luminaires that use maximum two tubular lamps, the minimum lamp compartment dimensions are tabulated below:

SKU #.	Model	MIN. distance between tubes installation lighting sign(inches)	MAX. Interconnected Unit
152727	BLT-ST812-3W-180-65K	3.94	20
152728	BLT-ST818-4.5W-180-65K	3.94	20
152729	BLT-ST830-7.5W-180-65K	3.94	20
152730	BLT-ST842-10.5W-180-65K	3.94	20
152731	BLT-ST812-6W-360-65K	3.94	20
152732	BLT-ST818-9W-360-65K	3.94	20
152733	BLT-ST830-15W-360-65K	3.94	20
152734	BLT-ST842-21W-360-65K	3.94	20



# SIGN STORM™

LED Sign Tube

## Dimensions

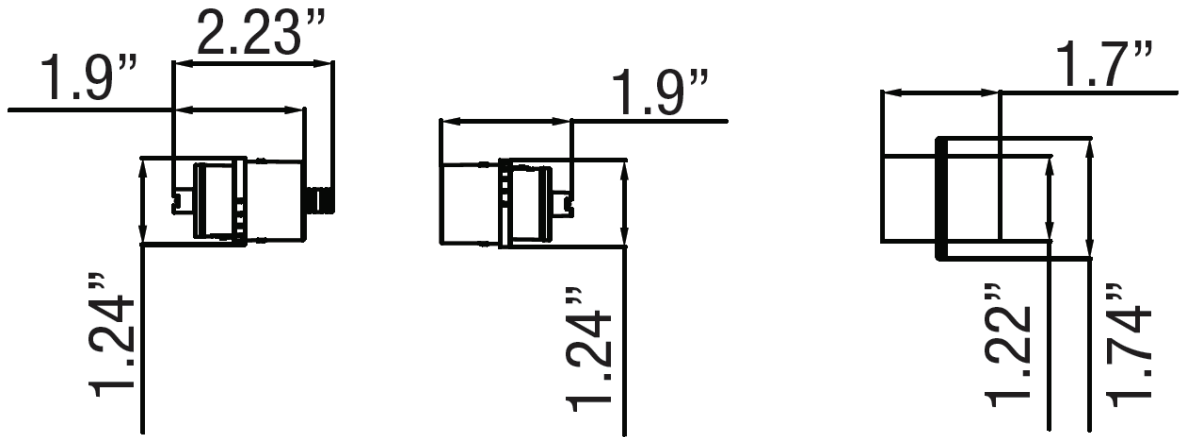

Single Sided

12" / 18" / 30" / 42"

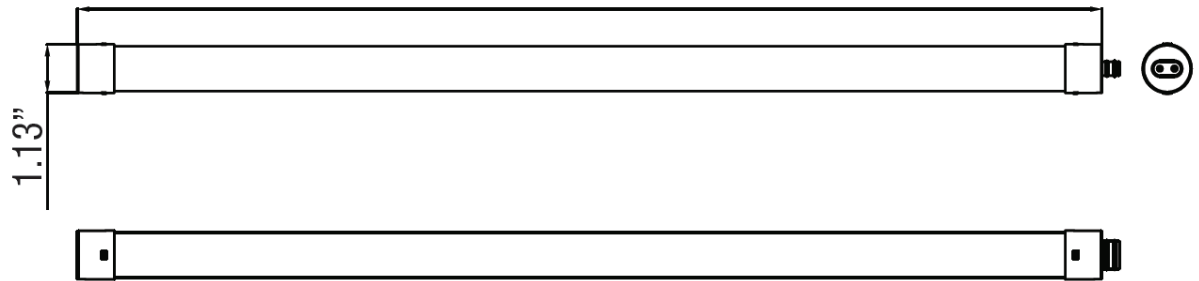

Double Sided

15.82" / 21.82" / 33.82" / 45.82"

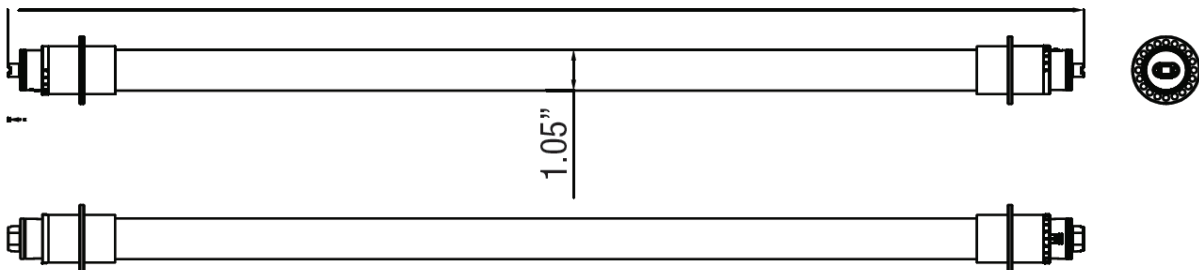

# SIGN STORM™

## LED Sign Tube



### SKU number 152727 Light Distribution Testing Parameters

#### Luminaire Data

Luminary Flux(lm):	375.486	Field Angle(10%Imax):	168.5(°)
Luminary Efficiency:	100.13%	Down Lumens&Percent:	361.370lm 96.24%
Luminary EER(lm/W):	134.102	Up Lumens&Percent:	14.116lm 3.76%
Max. Candela(cd):	143.906	S/MH:	C0_a180=2.780 C90_270=2.897
Max Cand@Ang. (°):	C=270.0 γ=64.0	CIE Type:	Semi-Direct
Beam Angle(50%Imax):	158.7(°)	ErP φuse(120°):	138.416lm
Left=-88.3°, Right=70.4°		IRF (%):	37.361

### Photometric Results

#### Distribution Diagram

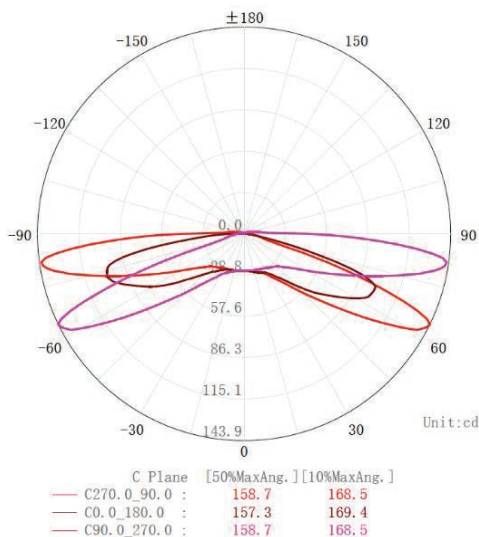

#### The Average Illuminance Effective Figure

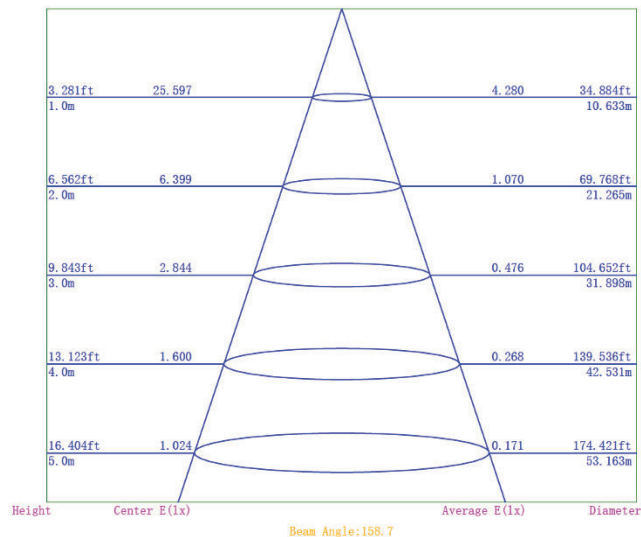



# SIGN STORM™

## LED Sign Tube

### SKU number 152728 Light Distribution Testing Parameters

#### Luminaire Data

Luminary Flux(lm):	457.733	Field Angle(10%Imax):	169.3(°)
Luminary Efficiency:	100.16%	Down Lumens&Percent:	441.952lm 96.55%
Luminary EER(lm/W):	123.712	Up Lumens&Percent:	15.781lm 3.45%
Max. Candela(cd):	172.787	S/MH:	C0_a180=2.568 C90_270=2.847
Max Cand@Ang. (°):	C=270.0 γ=65.0	CIE Type:	Semi-Direct
Beam Angle(50%Imax):	158.0(°)	ErP Φuse(120°):	167.848lm
	Left=-85.7°, Right=72.3°	IRF(%):	36.634

#### Photometric Results

#### Distribution Diagram

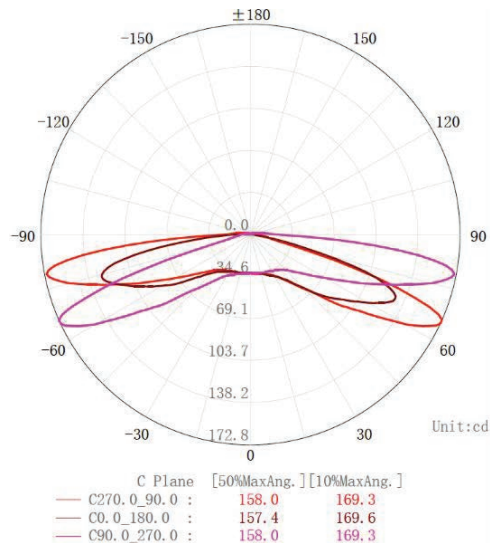

#### The Average Illuminance Effective Figure

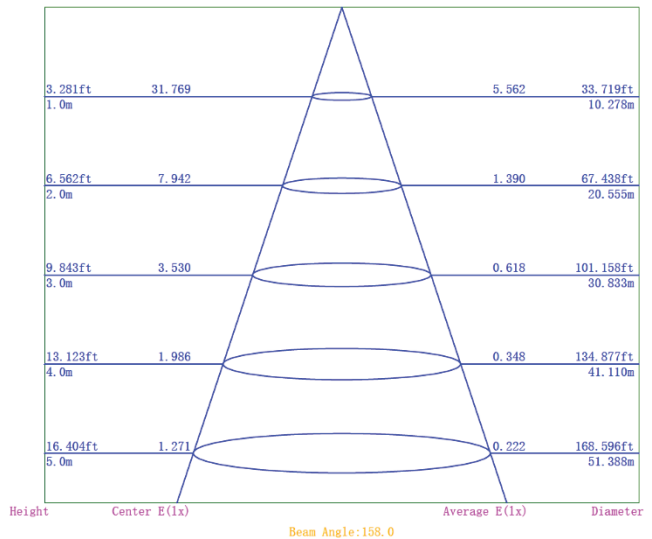

# SIGN STORM™

## LED Sign Tube



### SKU number 152729 Light Distribution Testing Parameters

#### Luminaire Data

Luminary Flux(lm):	1007.877	Field Angle(10%Imax):	169.4(°)
Luminary Efficiency:	100.09%	Down Lumens&Percent:	977.273lm 96.96%
Luminary EER(lm/W):	130.893	Up Lumens&Percent:	30.604lm 3.04%
Max. Candela(cd):	372.524	S/MH:	C0_a180=2.562 C90_270=2.573
Max Cand@Ang. (°):	C=300.0 $\gamma$ =68.0	CIE Type:	Semi-Direct
Beam Angle(50%Imax):	157.0(°)	ErP $\phi$ use(120°):	370.248lm
	Left=-82.2°, Right=74.8°	IRF(%):	36.946

### Photometric Results

#### Distribution Diagram

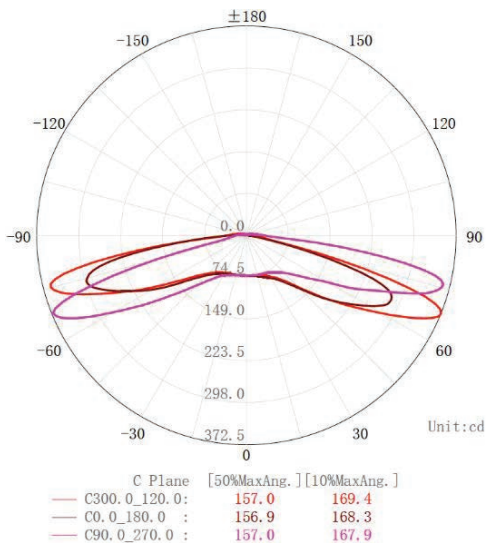

#### The Average Illuminance Effective Figure

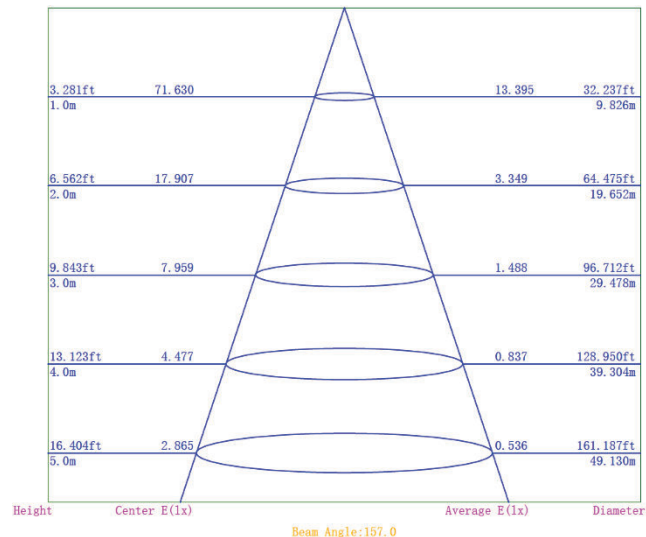



# SIGN STORM™

## LED Sign Tube

### SKU number 152730 Light Distribution Testing Parameters

#### Luminaire Data

Luminary Flux(lm):	1439.850	Field Angle(10%Imax):	167.7(°)
Luminary Efficiency:	100.06%	Down Lumens&Percent:	1395.890lm 96.95%
Luminary EER(lm/W):	130.895	Up Lumens&Percent:	43.960lm 3.05%
Max. Candela(cd):	547.290	S/MH:	C0_a180=2.636 C90_270=2.747
Max Cand@Ang. (°):	C=270.0 γ=67.0	CIE Type:	Semi-Direct
Beam Angle(50%Imax):	159.2(°)	ErP φuse(120°):	510.222lm
Left=-85.6°, Right=73.6°		IRF (%):	37.918

#### Photometric Results

##### Distribution Diagram

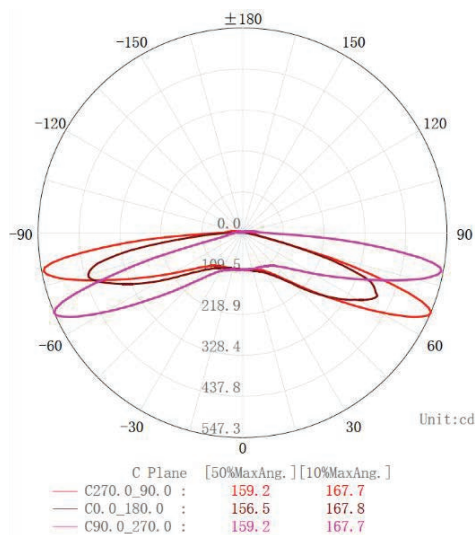

##### The Average Illuminance Effective Figure

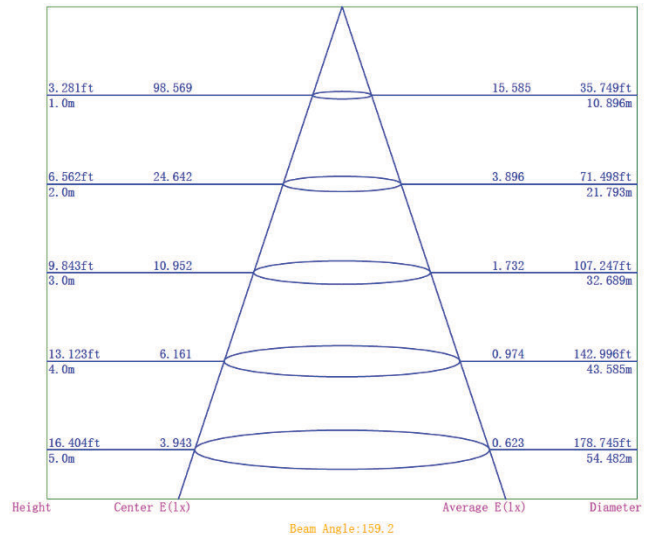

# SIGN STORM™

## LED Sign Tube



### SKU number 152731 Light Distribution Testing Parameters

#### Luminaire Data

Luminary Flux(lm):	646.466	Field Angle(10%Imax):	329.9(°)
Luminary Efficiency:	100.07%	Down Lumens&Percent:	399.935lm 61.86%
Luminary EER(lm/W):	104.269	Up Lumens&Percent:	246.531lm 38.14%
Max. Candela(cd):	157.841	S/MH:	C0_a180=1.485 C90_270=2.563
Max Cand@Ang. (°):	C=90.0 γ=23.0	CIE Type:	General Diffuse
Beam Angle(50%Imax):	66.6(°)	ErP φ use(120°):	239.743lm
	Left=-28.9°, Right=37.7°	IRF (%):	155.258

### Photometric Results

#### Distribution Diagram

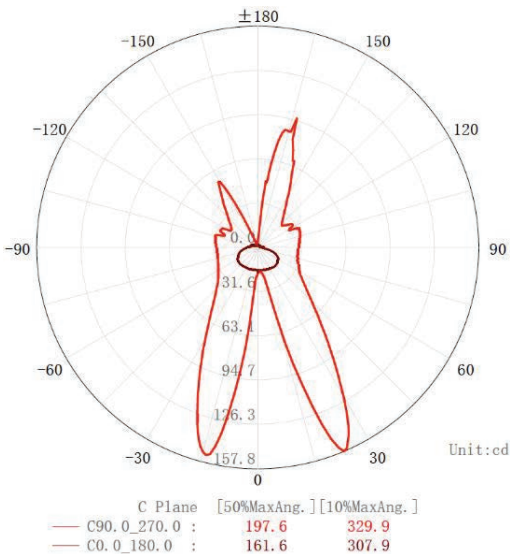

#### The Average Illuminance Effective Figure

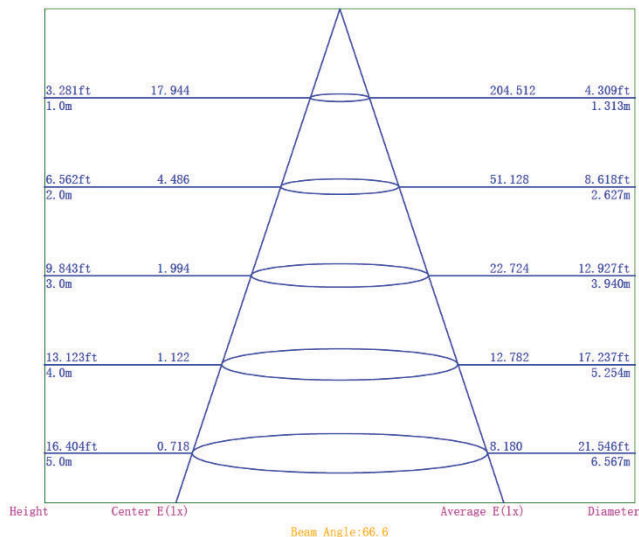



# SIGN STORM™

## LED Sign Tube

### SKU number 152732 Light Distribution Testing Parameters

#### Luminaire Data

Luminary Flux(lm):	907.472	Field Angle(10%Imax):	334.4(°)
Luminary Efficiency:	100.05%	Down Lumens&Percent:	544.173lm 59.97%
Luminary EER(lm/W):	96.540	Up Lumens&Percent:	363.298lm 40.03%
Max. Candela(cd):	238.798	S/MH:	C0_a180=1.245 C90_270=2.272
Max Cand@Ang. (°):	C=270.0 γ=10.0	CIE Type:	Semi-Indirect
Beam Angle(50%Imax):	60.9(°)	ErP Φ use(120°):	318.387lm
	Left=-35.0°, Right=25.9°	IRF (%):	192.381

#### Photometric Results

#### Distribution Diagram

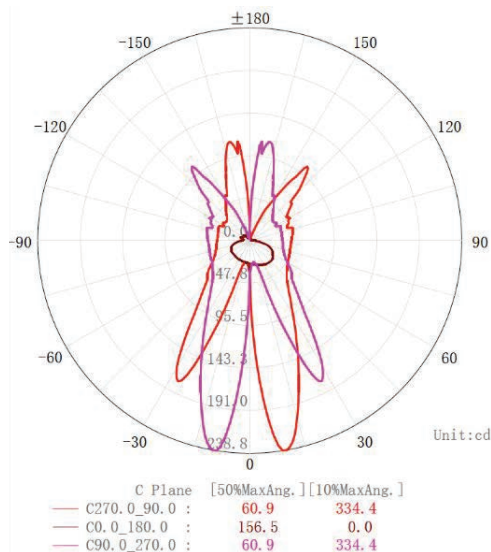

#### The Average Illuminance Effective Figure

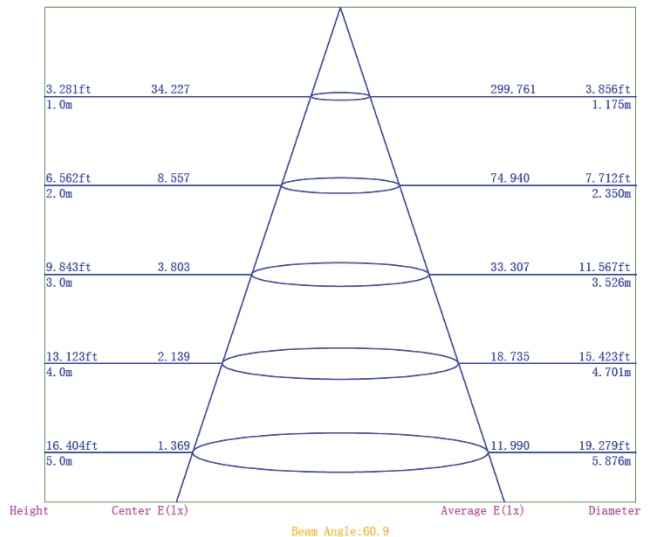

# SIGN STORM™

## LED Sign Tube



### SKU number 152733 Light Distribution Testing Parameters

#### Luminaire Data

Luminary Flux(lm):	1644.040	Field Angle(10%Imax):	333.0(°)
Luminary Efficiency:	100.00%	Down Lumens&Percent:	971.292lm 59.08%
Luminary EER(lm/W):	107.454	Up Lumens&Percent:	672.748lm 40.92%
Max. Candela(cd):	410.079	S/MH:	C0_a180=1.471 C90_270=2.575
Max Cand@Ang. (°):	C=90.0 γ=27.0	CIE Type:	Semi-Indirect
Beam Angle(50%Imax):	199.8(°)	ErP Φ use(120°):	577.601lm
Left=-156.5°, Right=43.3°		IRF (%):	144.802

### Photometric Results

#### Distribution Diagram

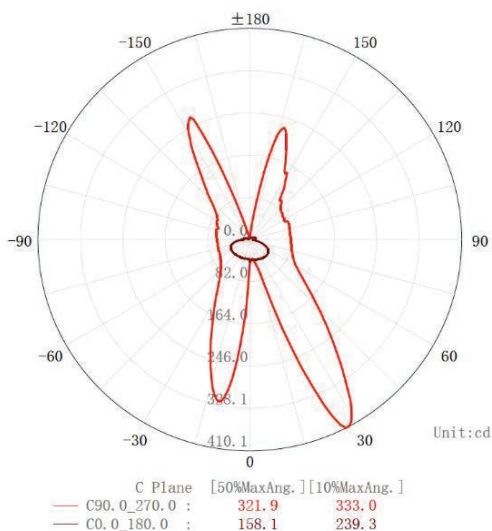

#### The Average Illuminance Effective Figure

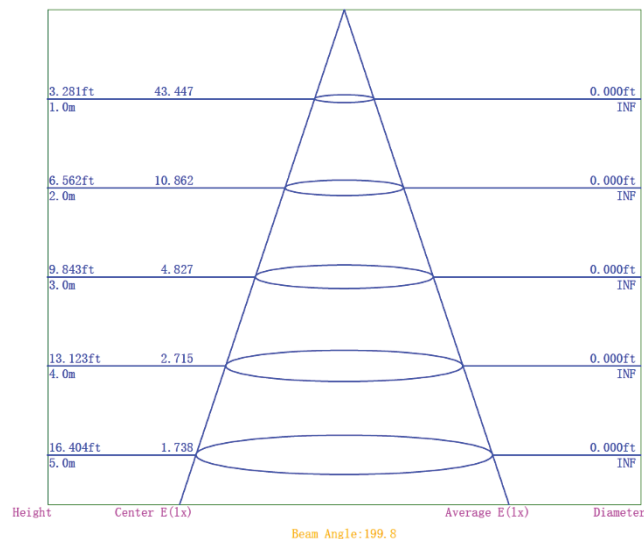

# SIGN STORM™

## LED Sign Tube

### SKU number 152734 Light Distribution Testing Parameters

#### Luminaire Data

Luminary Flux(lm):	2312.981	Field Angle(10%Imax):	360.0(°)
Luminary Efficiency:	99.83%	Down Lumens&Percent:	1325.993lm 57.33%
Luminary EER(lm/W):	106.589	Up Lumens&Percent:	986.988lm 42.67%
Max. Candela(cd):	566.224	S/MH:	C0_a180=1.411 C90_270=0.003
Max Cand@Ang. (°):	C=90.0 γ=19.0	CIE Type:	Semi-Indirect
Beam Angle(50%Imax):	64.3(°)	ErP φuse(120°):	771.124lm
Left=-29.8°, Right=34.5°		IRF(%):	192.650

#### Photometric Results

##### Distribution Diagram

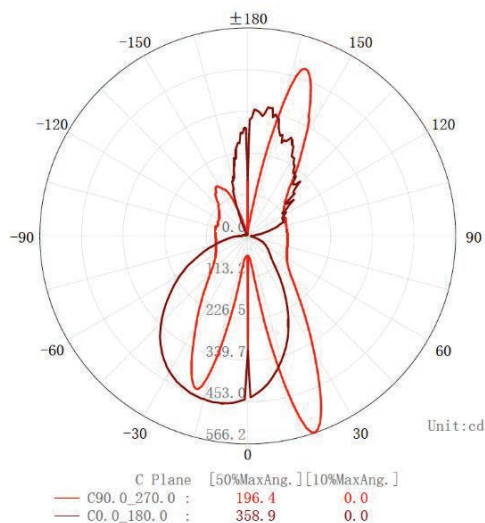

##### The Average Illuminance Effective Figure

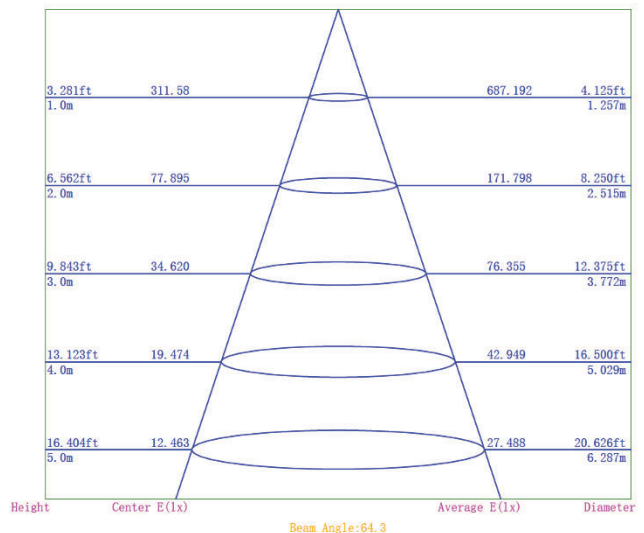

# SIGN STORM™

## LED Sign Tube



### Notes Before Installation

1. Be careful to open the carton, contact us if any damage.
2. This product must be installed in accordance with the applicable installation, code by a person familiar with the construction and operation of the product and the hazards involved.
3. “caution - risk of shock” and “disconnect power before servicing” when photoelectric switch provided.
4. Please check whether the voltage marked on the luminaire is consistent with the input voltage to be connected, so as not to damage the LED luminaire.
5. To ensure the lifetime of the product, please do not use it in a place with strong acid mist.
6. Make sure the installation position can withstand 10 times the weight of the luminaire before installation and install it at a flat place without vibration, no swing, no fire hazard.

### Caution

1. Do not use an electric generator to test the LED fixture.
2. Please abide by related country, regional and local law and regulations when install this fixture;
3. Do not install the fixture in raining days to avoid electrical shock or damage.

### Installation Instructions

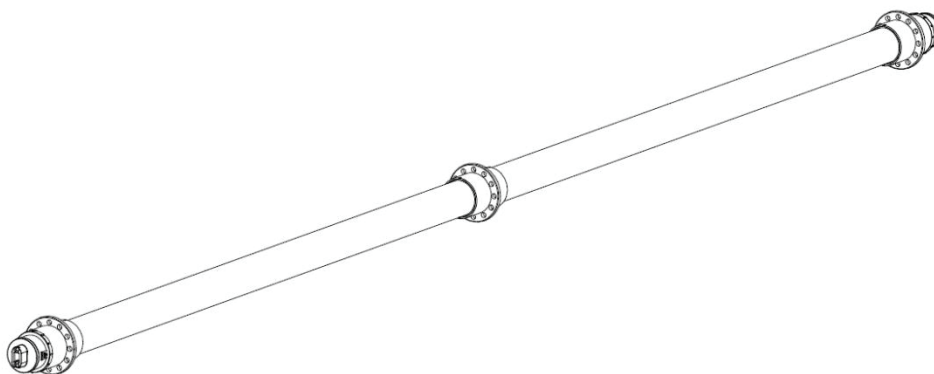

Please keep this Quick Installation Guide for future reference.  
Modifications to the product void the Warranty.  
Suitable to replace fluorescent lamps as specified on the product label.

# SIGN STORM™

## LED Sign Tube

### Notes Before Installation

#### 1. INSTALLATION OR ASSEMBLY INSTRUCTIONS

- a) Wiring instructions that specify the proper method of connecting the grounding means and maintaining polarity shall be included with the luminaire in a manner that will require the installer to handle the instructions during installation.
- b) Specification of mounting hardware shall be included in the instruction sheet.
- c) Other warnings that will not lead to misuse.

#### 2. THIS DEVICE IS NOT INTENDED FOR USE WITH EMERGENCY EXITS

3. **WARNING** – Risk of fire or electric shock. LED Retrofit Kit installation requires knowledge of sign electrical systems. If not qualified, do not attempt installation. Contact a qualified electrician.

4. **WARNING** – Risk of fire or electric shock. Install this kit only in host signs that have been identified in the installation instructions and where the input rating of the retrofit kit does not exceed the input rating of the sign.

5. **WARNING** – Risk of fire or electric shock. Installation of this LED retrofit kit may involve drilling or punching of holes into the structure of the sign. Check for enclosed wiring and components to avoid damage to wiring and electrical parts.

6. Installer should examine all parts that are not intended to be replaced by the retrofit kit for damage and replace any damaged parts prior to installation of the retrofit kit.

7. Installers should not disconnect existing wires from lamp holder terminals to make new connections at lamp holder terminals. Instead installers should cut existing lamp holder leads away from the lamp holder and make new electrical connections to lamp holder lead wires by employing applicable connectors.

8. Repair and seal any unused openings in the electrical enclosure. Openings greater than 0.5 inches diameter require a metal patch secured by screws or rivets and caulked with non-hardening caulk. Smaller openings may be sealed with non-hardening caulk.

9. **WARNING:** To avoid potential fire or shock hazard, do not use this retrofit kit with existing shunted bi pin lamp holders in the host sign. Note: Shunted lamp holders are found only in fluorescent signs with Instant-Start ballasts. Instant-start ballasts can be identified by the words "Instant Start" or "I.S." marked on the ballast. This designation may be in the form of a statement pertaining to the ballast itself, or may be combined with the marking for the lamps with which the ballast is intended to be used.



# SIGN STORM™

## LED Sign Tube



### Installation Guide

#### 1. DISCONNECT POWER OF LUMINAIRE

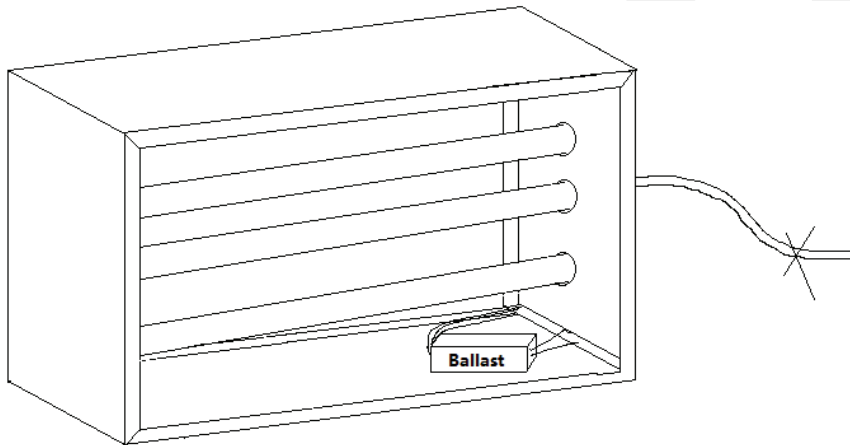

Disconnect power to luminaire or circuit (if possible). Ensure all power is off by using a voltmeter or other method to confirm.

#### 2. REMOVE EXISTING FLUORESCENT TUBE LAMP(S) AND BALLAST

- Remove fixture lens, if present.
- Remove existing fluorescent lamp(s).
- Expose the sign raceway to access the wiring. Then cut input and output wires from the ballast, and remove the ballast.

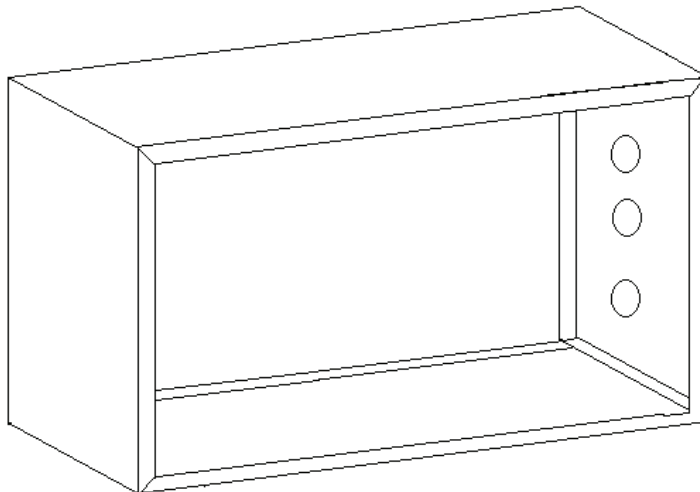

#### 3. FIXTURE REWIRING

- R17d lamp holder installation, please rewiring the fixture according to the below diagram.

# SIGN STORM™

## LED Sign Tube

### Installation Guide

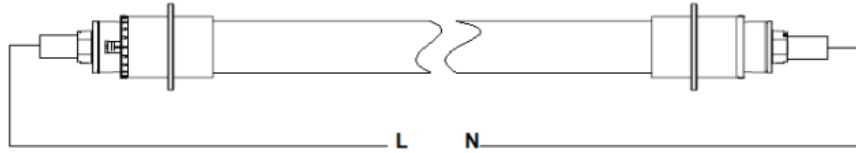

b. Power cord installation, please rewiring the fixture according to the below diagram.



#### 4. SIGN TUBE LIGHT ASSEMBLE

a. Please check the length of the original fluorescent tube, and then select the right components accordingly.

b. LED Sign tube light assemble

If R17d lamp holder installation, please assemble as shown below:

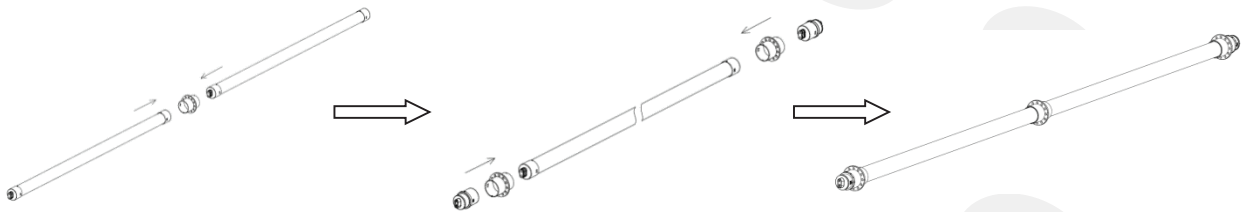

If Power cord installation, please assemble as shown below:

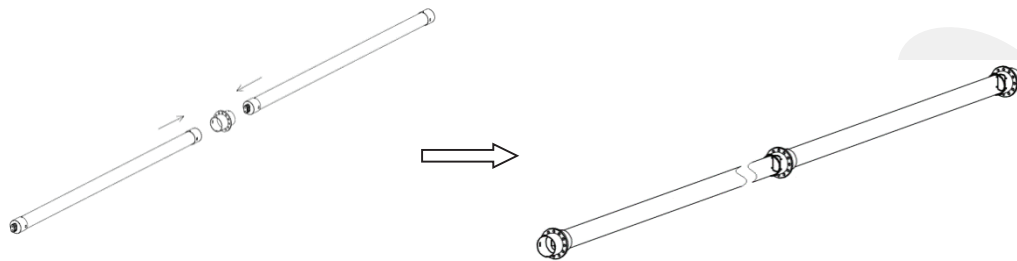

#### 5. INSERT LED SIGN TUBE LIGHTS

##### 5.1 R17d lamp holder installation

a. Read label on the lamp to ensure the power end of LED is aligned with powered tube socket, then insert LED lamp in the normal way by sliding pins into sockets and rotating a quarter turn until LED tube locks in place.

b. Repeat above step for all LED tube lamps.

c. Fix the hanging chain to hanging connector on the splicing part of the lamp, and hang up with chains one to one between connectors, as shown below.

d. LED lamps are now fully installed

# SIGN STORM™

## LED Sign Tube



### Installation Guide

- e. Replace troffer lens, if present.
- f. After modification completed. Attach the Replacement Marking and cautionary Label to a visible place on the luminaire and keep it visible after installation.

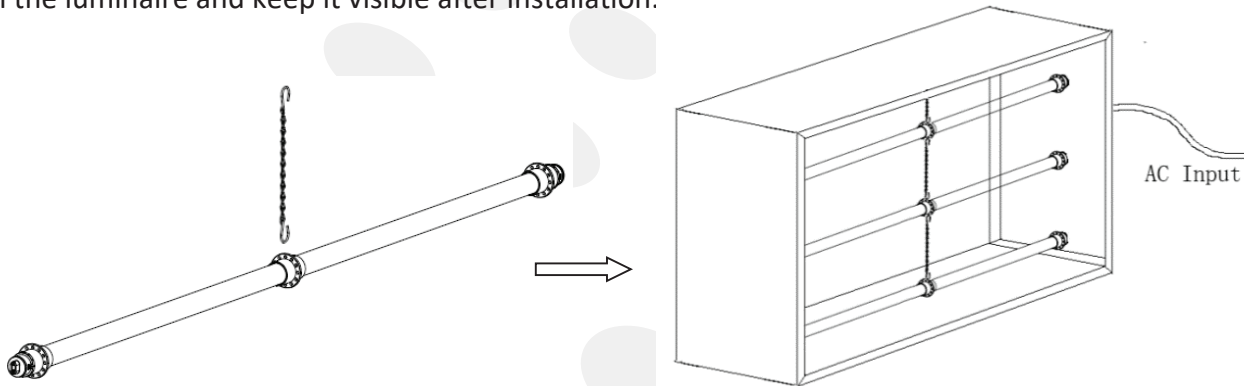

#### 5.2 Power cord installation

- a. Fix the hanging chain to hanging connectors on the splicing part and end caps of the lamp, and hang up with chains one to one between connectors, as shown below.
- b. Read label on the lamp on the bottom to ensure the power end of LED. Use connector cord to link the other end to the end of above lamp. Make sure the power of each circuit is not higher than 550W.
- c. Read label on the lamp on the bottom to ensure the power end of LED. Insert the power cord to the powered each end of the bottom lamp.
- d. Connect the power cords together to AC input wire
- e. LED lamps are now fully installed.
- f. Replace troffer lens, if present.
- g. After modification completed. Attach the Replacement Marking and cautionary Label to a visible place on the luminaire and keep it visible after installation.

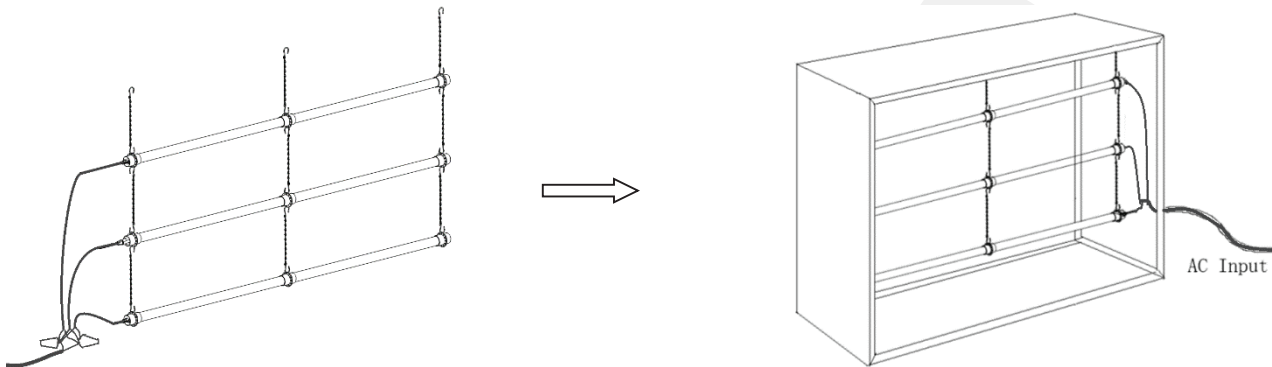

#### 6. RESTORE THE POWER OF LUMINAIRE

Restore power to circuit/luminaire and test light. If necessary, adjust position of LED tube, and enjoy your new LED tube light!

# SIGN STORM™

## LED Sign Tube

### Trouble Shooting

Troubles	Check points
Flickering of the light	Turn off the power and turn on again in 3 minutes. If same phenomena occur, then call agencies.
Out of working	Please check the connection.

### Packaging

SKU #.	Model	Carton Size (Inches)	Carton G.W (lbs)
152727	BLT-ST812-3W-180-65K	16.93 x 7.52 x 8.07	9.48
152728	BLT-ST818-4.5W-180-65K	22.83 x 7.52 x 8.07	12.57
152729	BLT-ST830-7.5W-180-65K	34.8 x 7.5 x 8.07	19.18
152730	BLT-ST842-10.5W-180-65K	46.8 x 7.5 x 8.07	26.01
152731	BLT-ST812-6W-360-65K	16.93 x 7.52 x 8.07	10.14
152732	BLT-ST818-9W-360-65K	22.83 x 7.52 x 8.07	12.79
152733	BLT-ST830-15W-360-65K	34.8 x 7.5 x 8.07	21.38
152734	BLT-ST842-21W-360-65K	46.8 x 7.5 x 8.07	28.66

# SIGN STORM™

## LED Sign Tube



### Application

Widely used in supermarket, warehouse, garage, home, office, hotel, hospital, school etc.

### Safety Precautions

To reduce the risk of death, personal injury or property damage from fire, electric shock, falling parts, cuts/abrasions, and other hazards read all warnings and instructions included with and on the fixture box and all fixture labels.

Before installing, servicing, or performing routine maintenance upon this equipment, follow these general precautions.

Commercial installation, service and maintenance of luminaires should be performed by a qualified licensed electrician.

For the installation: If you are unsure about the installation or maintenance of the luminaires, consult a qualified licensed electrician and check your local electrical code. To prevent wiring damage or abrasion, do not expose wiring to edges of sheet metal or other sharp objects. Do not make or alter any open holes in an enclosure of wiring or electrical components during kit installation.

#### WARNING: RISK OF FIRE OR ELECTRICAL SHOCK

Turn off electrical power at fuse or circuit breaker box before wiring fixture to the power supply. Turn off the power when you perform any maintenance.

Verify that supply voltage is correct by comparing it with the luminaire label information.

Make all electrical and grounded connections in accordance with the National Electrical Code and any applicable local code requirements. All wiring connections should be capped with UL approved wire connectors.

#### CAUTION: RISK OF INJURY

Avoid direct eye exposure to the light source while it is on.

Account for small parts and destroy packing material, as these may be hazardous to children.

### Warranty

5 Years Warranty