

CES-EX-LN-02P Series LED Luminaires

CESP

Hazardous Locations



HazLoc

Applications:

Wastewater treatment, oil and gas refineries, drilling rigs, petrochemical facilities, food and beverage facilities, tunnels, outdoor wall and stanchion mounted general area lighting, and where flammable vapors, gases are present.

- Available from 30W ($\geq 3,600\text{lm}$) - 75W ($\geq 9,000\text{lm}$);
- Offered with 3 mounting options: Ceiling Mount, Drop mount, Wall mounting;
- Wide optics for uniform illumination;
- Entry Size: 3/4"-14 NPT or M25 X1.5 or M26 X1.5;
- 50,000+ hours LED lifespan;



CESP's warranty is subject to all terms and conditions found at cesplex.com/warranty.

- Class I, Division 2, Groups A, B, C and D;
- Damp and wet locations;

Standard :

US: UL 844; UL 1598;

Canada: CSA C22.2 No. 137; CSA C22.2 No. 250.0;



Standard product picture



CES-EX-LN-02P-(40D~75D)

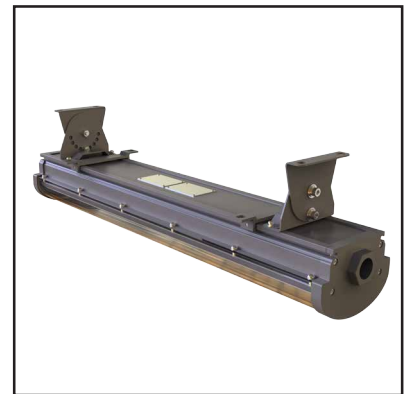

CES-EX-LN-02P-(30B~50B)

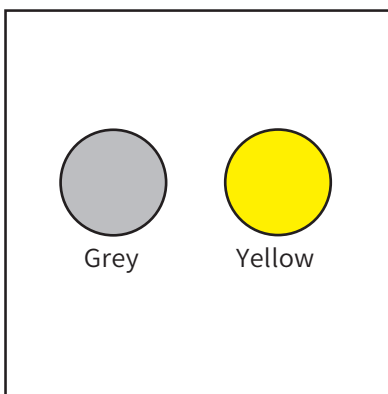

Yellow/grey available
(grey has no texture)



The CESP is a complete cutoff, fully shielded area light that minimizes glare, while reducing light trespass. (The maximum luminous beam angle 120°)

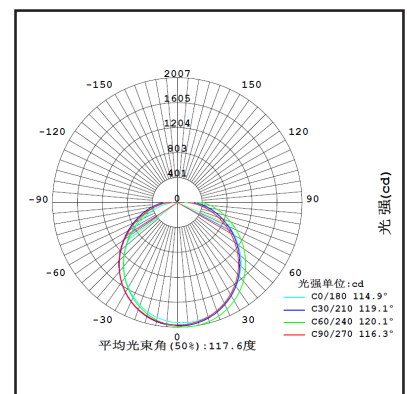

Photometric Data (120°)

Specifications

UL:

Suitable for wet locations
 Operating temperature: -40°C to +55°C (-40°F to 131°F)

LEDs:

Long-life, high-efficiency, surface mount LEDs

Drivers(s):

Class 2, 50/60Hz. 100 - 277V, 4kV standard, 6kV optional surge protection

Lifespan:

50,000+ hours LED lifespan based on IES LM-80 results & TM-21 calculations at 25°C, and ERP>6000h

IP Rating:

IEC60598 Ingress Protection rating of IP66 for dust and water

Housing:

Die-cast aluminum housing

Mounting:

Ceiling Mount, Drop mount, Wall mounting

Lens:

High transmittance tempered glass

Effective Projected Area:

EPA = 0.61

CCT:

Available in 3000K-6500K color temperature

CRI:

CRI ≥70

Beam angle:

The maximum luminous beam angle 120°

Color Stability:

LED color temperature is warranted to shift no more than 200K in CCT over a 5-years period

Color Uniformity:

CESP's range of CCT (Correlated Color Temperature) follows the guidelines of the American National Standard for Specifications for the Chromaticity of Solid State Lighting (SSL) Products, ERP C78.377-2017.

Finish:

Formulated for high durability and long-lasting color

Green Technology:

Mercury and UV free. RoHS-compliant components

IESNA LM-79 Testing:

CESP LED luminaires have been tested by an independent laboratory in accordance with IESNALM-79 and IEC60598

Product size:

Series models	Size(L×W×H)
CES-EX-LN-02P-75D	1229×125×88.7 mm/48.4×4.9×3.5"
CES-EX-LN-02P-65D	1229×125×88.7 mm/48.4×4.9×3.5"
CES-EX-LN-02P-60D	1229×125×88.7 mm/48.4×4.9×3.5"
CES-EX-LN-02P-50D	1229×125×88.7 mm/48.4×4.9×3.5"
CES-EX-LN-02P-40D	1229×125×88.7 mm/48.4×4.9×3.5"
CES-EX-LN-02P-50B	629×125×88.7 mm/24.8×4.9×3.5"
CES-EX-LN-02P-40B	629×125×88.7 mm/24.8×4.9×3.5"
CES-EX-LN-02P-30B	629×125×88.7 mm/24.8×4.9×3.5"

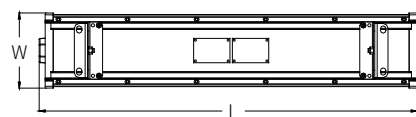
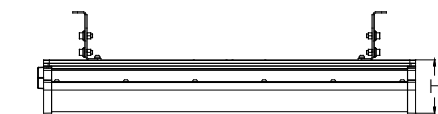

CES-EX-LN-02P-(30B~50B)

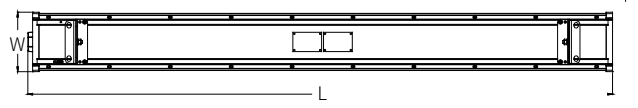
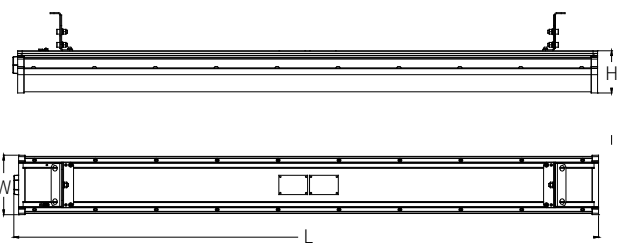

CES-EX-LN-02P-(40D~75D)

Performance and Packaging

Performance

ProductModel	CES-EX-LN-02P-(40D~75D)	CES-EX-LN-02P-(30B~50B)
Type	LED Explosion proof Linear Light	LED Explosion proof Linear Light
Mounting	Ceiling Mount /Drop mount/Wall mounting	Ceiling Mount /Drop mount/Wall mounting
Power (W)	40W / 50W / 60W / 65W / 75W	30W / 40W / 50W
Voltage - Frequency	100-277Vac 50-60Hz	100-277Vac 50-60Hz
CCT	Provides 3000K to 6500K	Provides 3000K to 6500K
CRI (Ra) (typ.)	≥70	≥70
Luminous Flux (lm)	120~140lm/W	120~140lm/W
Bare Lamp efficacy (LPW)	140	140
Beam Angle	120°	120°
Power Factor	>0.95	>0.95
Rated Lifetime - L70 (hrs.)	50,000	50,000
Product Size (L×W×H)	1229×125×88.7 mm/48.4×4.9×3.5"	629×125×88.7 mm/24.8×4.9×3.5"
Housing	ADC12 and 6063 Aluminum+PC	ADC12 and 6063 Aluminum+PC

Packaging

Product Model	Product Size (L×W×H)	Carton Size	QTY/CTN	Net Weight	Gross Weight
CES-EX-LN-02P-75D	1229×125×88.7 mm/48.4×4.9×3.5"	To be confirmed	1	5.5 kg/12.1 lbs	To be confirmed
CES-EX-LN-02P-65D	1229×125×88.7 mm/48.4×4.9×3.5"	To be confirmed	1	5.5 kg/12.1 lbs	To be confirmed
CES-EX-LN-02P-60D	1229×125×88.7 mm/48.4×4.9×3.5"	To be confirmed	1	5.5 kg/12.1 lbs	To be confirmed
CES-EX-LN-02P-50D	1229×125×88.7 mm/48.4×4.9×3.5"	To be confirmed	1	5.5 kg/12.1 lbs	To be confirmed
CES-EX-LN-02P-40D	1229×125×88.7 mm/48.4×4.9×3.5"	To be confirmed	1	5.5 kg/12.1 lbs	To be confirmed
CES-EX-LN-02P-50B	629×125×88.7 mm/24.8×4.9×3.5"	To be confirmed	1	3 kg/6.6 lbs	To be confirmed
CES-EX-LN-02P-40B	629×125×88.7 mm/24.8×4.9×3.5"	To be confirmed	1	3 kg/6.6 lbs	To be confirmed
CES-EX-LN-02P-30B	629×125×88.7 mm/24.8×4.9×3.5"	To be confirmed	1	3 kg/6.6 lbs	To be confirmed

Mountings

Ceiling mount

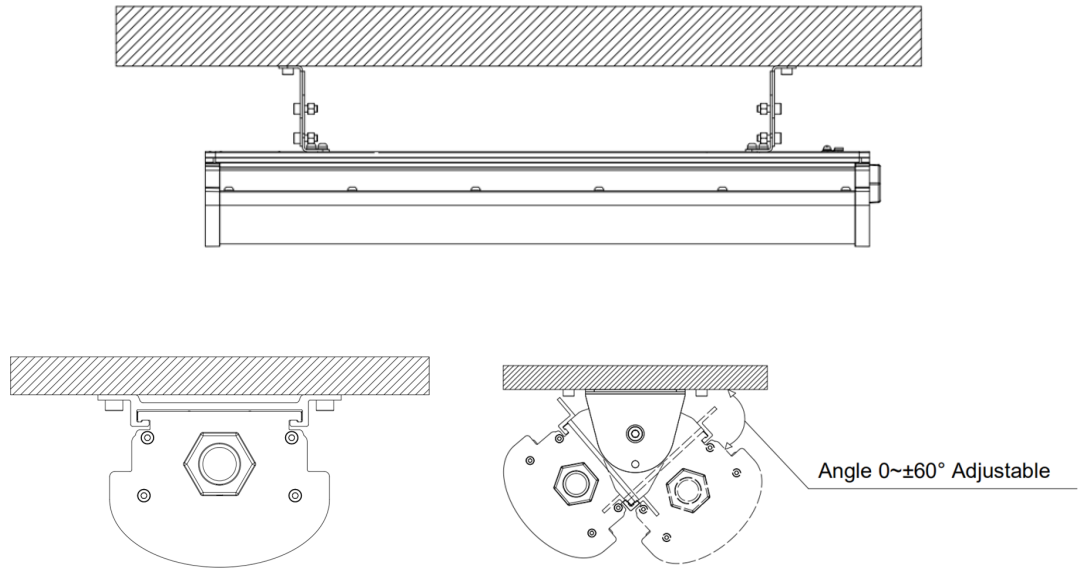

Drop mount

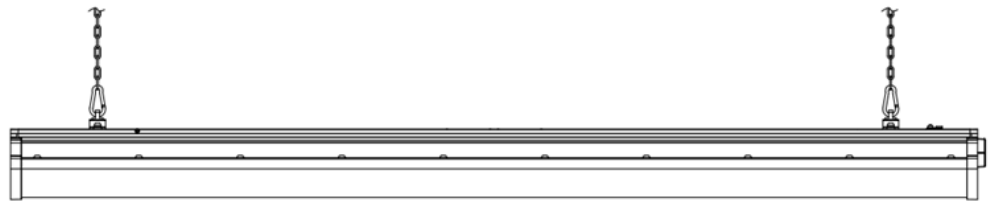

Wall mounting

