

CLP-ACRN architectural LED Fixture, suitable for wet locations. Perfect for lighting up Residential Exteriors, Walkways, Perimeters, School Campuses, Industrial/ Commercial Spaces, Parking Lots, Recreational Parks. This fixture has a wide light distribution.
 - 10 year/100,000 hour limited warranty.

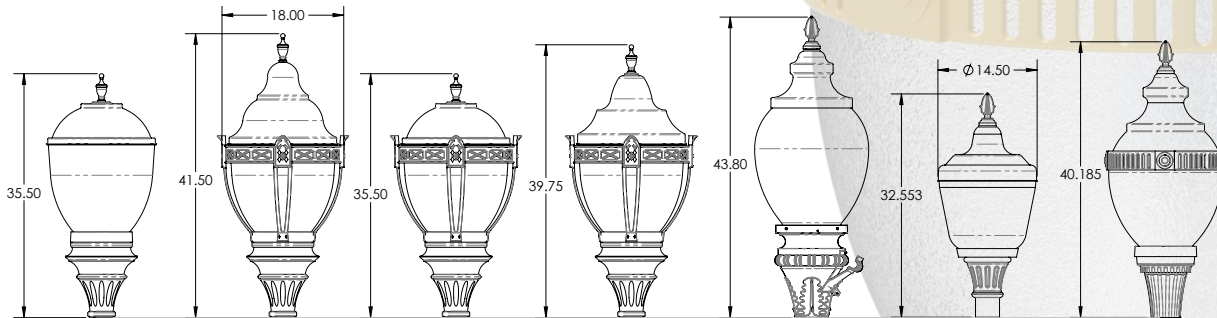

EPA	2.3
Weight	22LBS

Average Height and Diameter



Optic Distributions

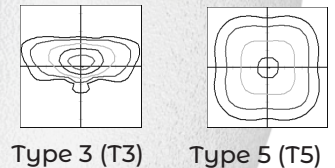

Example: CLP-ACRN-CG1-FT1-TP1-LLA-40CLEd-T3-30K-MV-BLK-PC



Cat #	Cage	Fitter	Hard Top	Lens	Wattage	Light Dist.	Color Temp.	Voltage	Finish	Options
CLP-ACRN										
CLP-Acorn (CLP-ACRN)	Cage 1 (CG1) Lens D or Lens A-L only	Fitter 1 (FT1) Fitter 2 (FT2) *Fitter 2		Lens A-L only Top 1 (TP1) Top 2 (TP2) Top 3 (TP3)	20W (20CLEd) 40W (40CLEd) 50W (50CLEd) 60W (60CLEd) 80W (80CLEd)	Type 3 (T3) Type 5 (T5)	3000K (30K) 4000K (40K) 5000K (50K)	120-277V (MV) 480V (HV)	Black (BLK) White (WHT) Silver (SLR) Bronze (BRZ) Graphite (GPH) Custom (CST)	Occupancy Sensor (OCC) Bottom Photo Cell (PC) 7Pin Photocell Receptacle & Shoring Cap (7PCR) (Hard Top Only) Wireless Control (WC)
	Cage 2 (CG2)	Large (FT2L) *Lens E 9"OD Base *MNT over 4"OD Fitter 3 (FT3) Fitter 4 (FT4) Fitter 5 (FT5) **Fitter 6 (FT6) **MNT over 5"OD Fitter 7 (FT7)	Lens A-S, B or D only Top 1-S (TP1-S) Lens E only Top 4 (TP4)							



Hard Top 1



Hard Top 1-S



Hard Top 2



Hard Top 3



Hard Top 4



Lens A-S



Lens A-L



Lens B



Lens D



Lens E



Fitter 1



Fitter 2



Fitter 2L



Fitter 3



Fitter 4



Fitter 5



Fitter 6



Fitter 7



Cage 1



Cage 2



Finial 1



Finial 2

Cat #	Input Power	Lumen Output	LPW	Color Temp. (CCT)	CRI	Rated Life (L70)	Input Voltage	HID Equivalent
CLP-ACRN-20CLED	25W	3,680	184	5000K	70+	>200,000	120-277V	50W MH
CLP-ACRN-40CLED	45W	6,492	162	5000K	70+	>200,000	120-277V	150W MH
CLP-ACRN-50CLED	55W	7,780	155	5000K	70+	>200,000	120-277V	250W MH
CLP-ACRN-60CLED	65W	8,539	142	5000K	70+	>200,000	120-277V	175W PSMH
CLP-ACRN-80CLED	85W	9,590	119	5000K	70+	>200,000	120-277V	250W PSMH



Anaheim Architectural LED Luminaire, suitable for wet locations. Perfect for lighting up Historical Buildings, Parks or Streets, Perimeters, Residential Exteriors, Walkways, or Perimeters, School Campuses, Industrial or Commercial Spaces, Parking Lots, Recreational Parks. This fixture has a wide light distribution.
 - 10 year/100,000 hour limited warranty.

Construction.

- Housing is Heavy-Duty Cast Aluminum Base.
- Powder Coat Bronze Finish (Standard). Various colors available (custom).
- Clear Acrylic Lens (Standard), Clear Polycarbonate Lens (optional).
- Silicone Gasket to prevent leakage and provide weather-tight protection.

Mounting.

- 3"O.D Tenon or Pole (Standard), Adapter is Required for other mountings.

Light Distribution.

- Type 5 or Type 3 (Per Order)

Cat #	Input Power	Lumen Output	LPW	Color Temp. (CCT)	CRI	Rated Life (L70)	Input Voltage	HID Equivalent
CLP-ACRN-20CLEd	25W	3,680	184	5000K	70+	>200,000	120-277V	50W MH
CLP-ACRN-40CLEd	45W	6,492	162	5000K	70+	>200,000	120-277V	150W MH
CLP-ACRN-50CLEd	55W	7,780	155	5000K	70+	>200,000	120-277V	250W MH
CLP-ACRN-60CLEd	65W	8,539	142	5000K	70+	>200,000	120-277V	175W PSMH
CLP-ACRN-80CLEd	85W	9,590	119	5000K	70+	>200,000	120-277V	250W PSMH

Average Height and Diameter

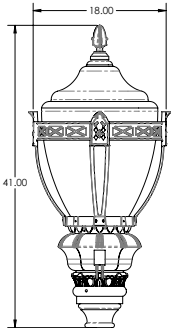

EPA	2.3
Weight	22LBS

Optic Distributions

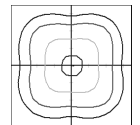
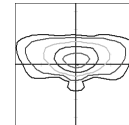

Type 3 (T3)

Type 5 (T5)

Example: ANHM-40CLEd-T3-30K-MV-BLK-PC



Cat #	Wattage	Light Dist.	Color Temp.	Voltage	Finish	Options
ANHM						
Anaheim (ANHM)	20W (20CLEd)	Type 3 (T3)	3000K (30K)	120-277V (MV)	Black (BLK)	Occupancy Sensor (OCC)
	40W (40CLEd)	Type 5 (T5)	4000K (40K)	480V (HV)	White (WHT)	Bottom Photo Cell (PC)
	50W (50CLEd)		5000K (50K)		Silver (SLR)	
	60W (60CLEd)				Bronze (BRZ)	7Pin Photocell Receptacle & Shoring Cap (7PCR)
	80W (80CLEd)				Graphite (GPH)	
					Custom (CST)	Wireless Control (WC)

Galveston Architectural LED Luminaire, suitable for wet locations. Perfect for lighting up Historical Buildings, Parks or Streets, Perimeters, Residential Exteriors, Walkways, or Perimeters, School Campuses, Industrial or Commercial Spaces, Parking Lots, Recreational Parks. This fixture has a wide light distribution.

- 10 year/100,000 hour limited warranty.

Construction.

- Housing is Heavy-Duty Cast Aluminum Base.
- Powder Coat Bronze Finish (Standard). Various colors available (custom).
- Clear Acrylic Lens (Standard), Clear Polycarbonate Lens (optional).
- Silicone Gasket to prevent leakage and provide weather-tight protection.

Mounting: .35" O.D Tenon or Pole (Standard), Adapter is Required for other mountings.

Light Distribution: Type 5 or Type 3 (Per Order)



Top Options



LA



LA-HT1



LA-HT2



LA-HT3

Cat #	Input Power	Lumen Output	LPW	Color Temp. (CCT)	CRI	Rated Life (L70)	Input Voltage	HID Equivalent
CLP-ACRN-20CLEd	25W	3,680	184	5000K	70+	>200,000	120-277V	50W MH
CLP-ACRN-40CLEd	45W	6,492	162	5000K	70+	>200,000	120-277V	150W MH
CLP-ACRN-50CLEd	55W	7,780	155	5000K	70+	>200,000	120-277V	250W MH
CLP-ACRN-60CLEd	65W	8,539	142	5000K	70+	>200,000	120-277V	175W PSMH
CLP-ACRN-80CLEd	85W	9,590	119	5000K	70+	>200,000	120-277V	250W PSMH

Average Height and Diameter

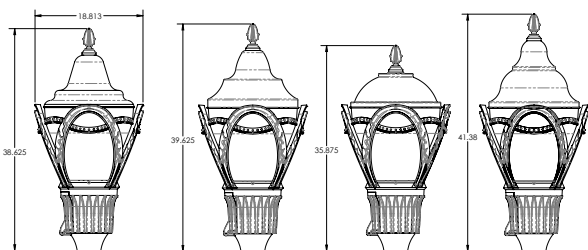

Optic Distributions

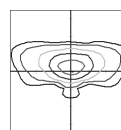

Type 3 (T3)

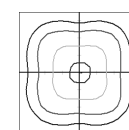

Type 5 (T5)

EPA	2.3
Weight	22LBS

Example: GLVTN-TP1-LLA-FNL2-40CLEd-T3-30K-MV-BLK-PC



Cat #	Hard Top	Lens/ Finial	Wattage	Light Dist.	Color Temp.	Voltage	Finish	Options
GLVTN								
Galveston (GLVTN)	No HT (NHT) Top 1 (TP1) Top 2 (TP2) Top 3 (TP3)	Large Lens A (LLA)	20W (20CLEd) 40W (40CLEd) 50W (50CLEd) 60W (60CLEd) 80W (80CLEd)	Type 3 (T3) Type 5 (T5)	3000K (30K) 4000K (40K) 5000K (50K)	120-277V (MV) 480V (HV)	Black (BLK) White (WHT) Silver (SLR) Bronze (BRZ) Graphite (GPH) Custom (CST)	Occupancy Sensor (OCC) Bottom Photo Cell (PC) 7Pin Photocell Receptacle & Shoring Cap (7PCR) (Hard Top Only) Wireless Control (WC)
	*Lens A-L only	Finial Finial 2 (FNL2) No Finial (nFNL)						