

STAR SERIES LED Street Light

E-LITE semicon

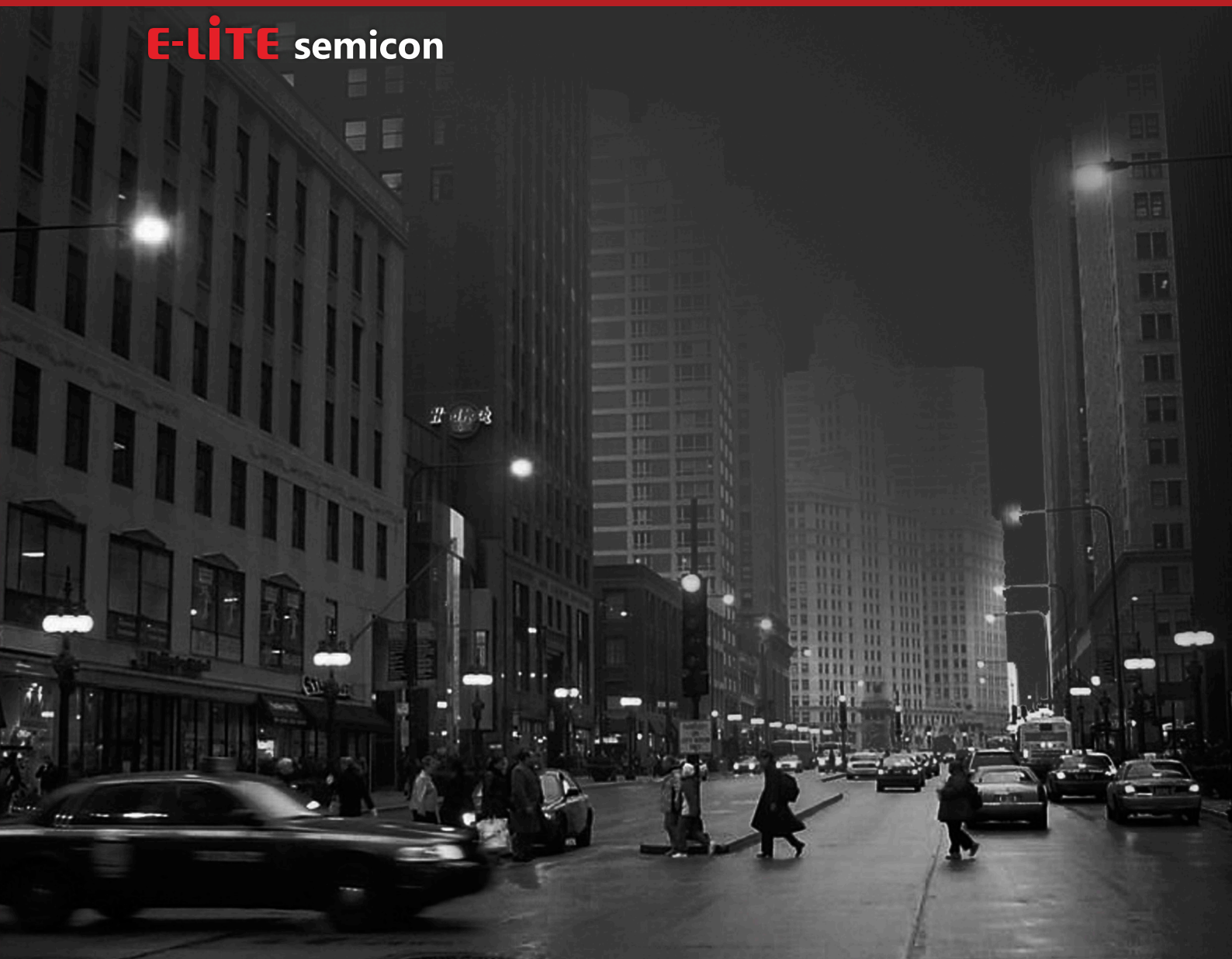

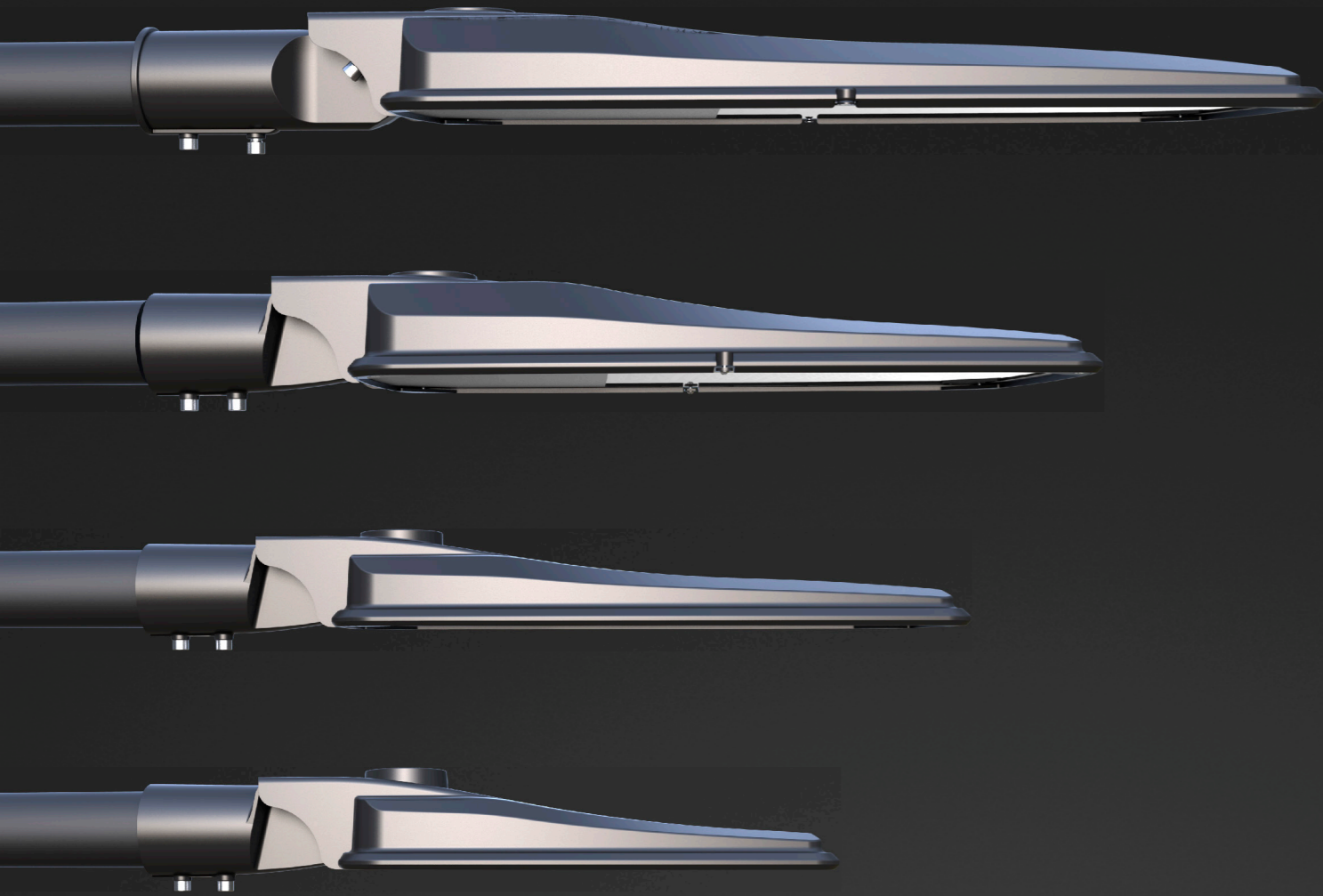

EFFICIENT ECONOMIC CONVENIENT

Star is a range of highly efficient yet budget-friendly outdoor luminaire. It works at 130LPW, IP66 and IK08 rated for reliable outdoor operation. Delivering high performance and energy efficiency at an affordable price. Star is ideal for various landscapes from pedestrian areas, streets, roads to car parks and even motorways.



APPLICATIONS

Discover Star

Star is available in different wattage and with lumen packages from 3,900 to 31,200 lumens (lm), providing comfortable, efficient light to reveal the urban streets.

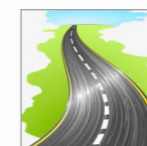

Roads & Motorways



Urban & Residential Streets

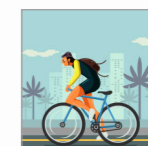

Bike & Pedestrian Paths

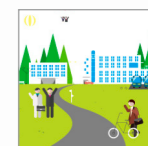

Squares & Pedestrian Areas



Bridges



Large Areas



Railway Station & Metros



Car Parks

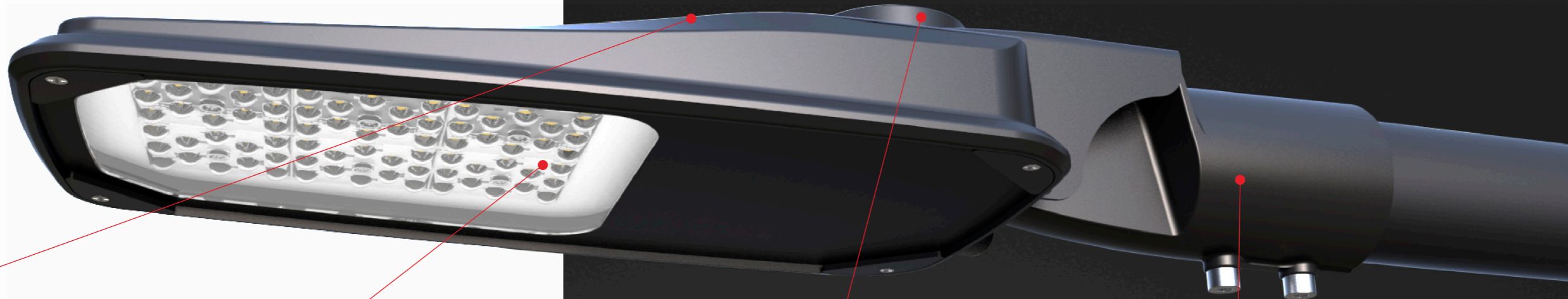

Materials/finish:

The Luminaire body is die-cast aluminum alloy protected with corrosive resistant resistant grey polyester powder coat finish.



Optics:

Optical systems for outdoor luminaires must be designed to satisfy several criteria in terms of luminaire performance. With a variety of light distributions, Star light engine features best in class optical performances. It is designed for convenience and economics, achieving wide column spacing, excellent uniformity plus no waste or obtrusive light.

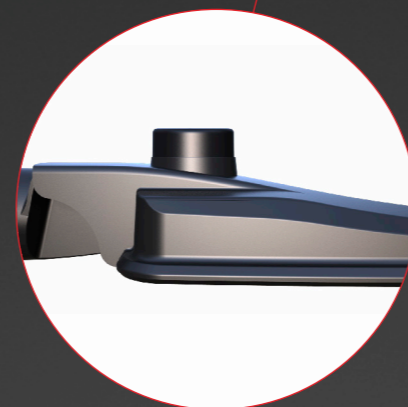

Ready To Connect:

Future proof luminaire with removable control gear and optic also compatible with any existing IoT options on the market thanks to the NEMA socket option. There are also 3/5/7 pins for you to choose from.

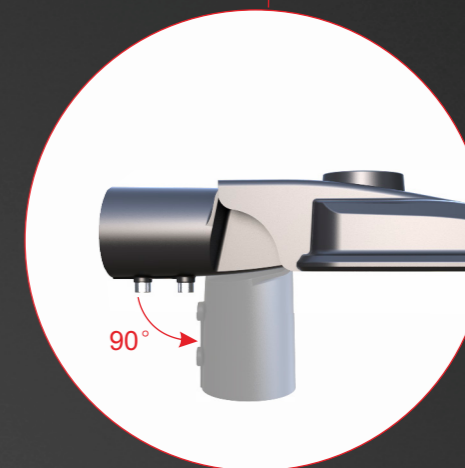

Installation:

Star series street lights are easy to install without burying cables, rectifiers, and so on. They can be directly installed on the lamp pole. There is adjustable spigot 0°/90°.

PRODUCT FEATURES

- System Light Efficacy 130LPW.
- Multiple Choice of Optical Lenses.
- 3G Vibration & IK08 Impact Resistance.
- IP66 Water and Dust Proof.
- Easy to Install and Maintain.
- Five Years Warranty.

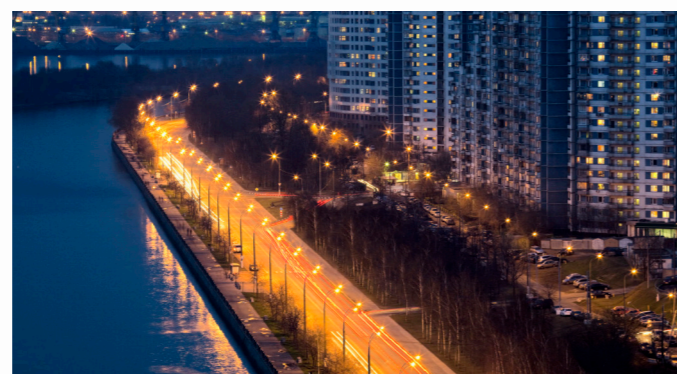

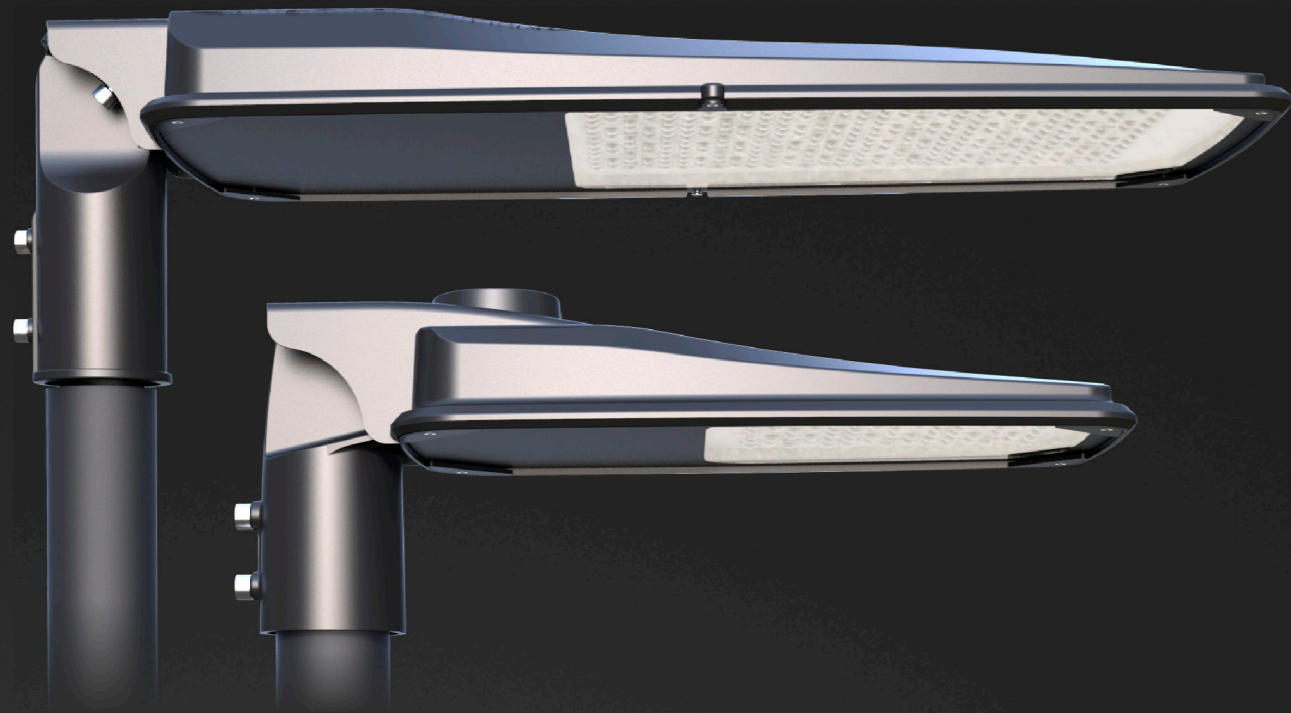

PERFORMANCE

LED Chips	Philips Lumileds 3030
Input Voltage	100-277 VAC (347/480 VAC Optional) Dimming Optional
Color Temperature	5000K(2500-6500K Optional)
Lumen Maintenance	L70>120,000 Hours (Calculated Using Tm-21 Calculator)
IP	IP66
IK	IK08
Power Factor	0.95 minimum
THD	20% Max
Dimming	0-10V / 1-10V Dimming
Control	Plug-and-Play Microwave Motion Sensor Optional
Housing Material	Aluminum alloy
Work Temperature	-30°C ~ 45°C / -22°F~ 113°F
Storing Temperature	-40 to 80°C (-40 to 176°F)
WARRANTY	5 Years

SPECIFICATIONS

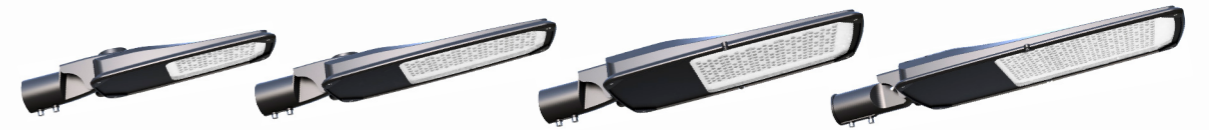

Part#	Power	Efficacy(IES)	Total Lumen	Product Dimensions
EO-STSA-60	30W	130 lm/W	3,900lm	513x180x85mm
	50W	130 lm/W	6,500lm	
	60W	130 lm/W	7,800lm	
EO-STSA-120	70W	130 lm/W	9,100lm	613x206x84mm
	80W	130 lm/W	10,400lm	
	90W	130 lm/W	11,700lm	
	100W	130 lm/W	13,000lm	
	120W	130 lm/W	15,600lm	
EO-STSA-150	150W	130 lm/W	19,500lm	633x279x87mm
EO-STSA-200	200W	130 lm/W	26,000lm	776x309x89mm
	240W	130 lm/W	31,200lm	

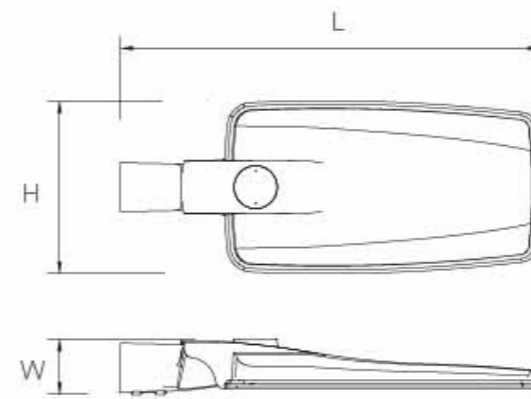

PHOTOMETRICS

Optimized Comfort

In many urban road applications, comfort is a key standard. The optics of Star series light is designed to enhance comfort with reduced glare.

70 x 140 (TYPE II-S)

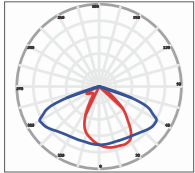

0.0-180.0
90.0-270.0

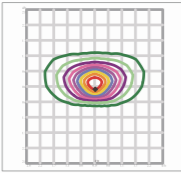

Mount Height(m): 6

70 x 150 (TYPE II-M)

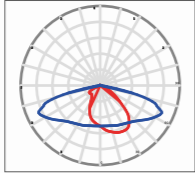

0.0-180.0
90.0-270.0

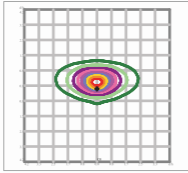

Mount Height(m): 8

95 x 150 (TYPE III-S)

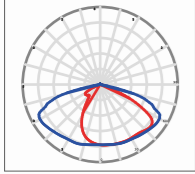

0.0-180.0
90.0-270.0

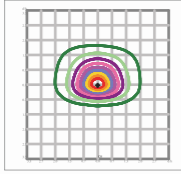

Mount Height(m): 6



Much more than a budget-friendly outdoor luminaire with the latest generation of LED modules, Star is highly convenient yet. Available in different discrete sizes, it is designed to maximize lighting performance, and realize an economic and convenient dual road strategy. At the same time, it limits carbon emissions and achieves a green cycle.

Thanks to Star's high performance and substantial benefits, it is the perfect answer to the current and future project needs.

A FUTURE PROOF SOLUTION

Smart City

iNET™ Intelligent Lighting Monitor & Control System is a cloud based wireless smart system designated for lighting management.

With gateways + control node., iNET™ System monitors lights performance status, collects operation data, controls lights on/off or dimming, and sends alarm in case of fault detected.

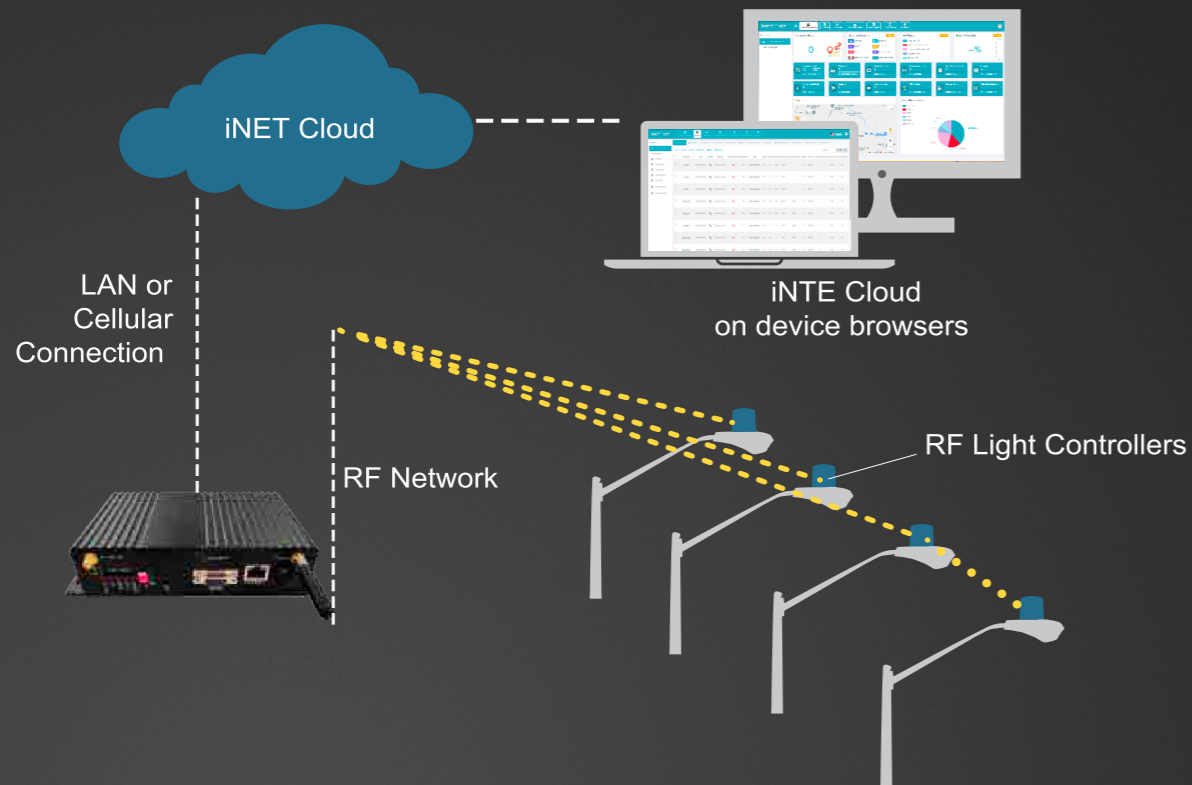
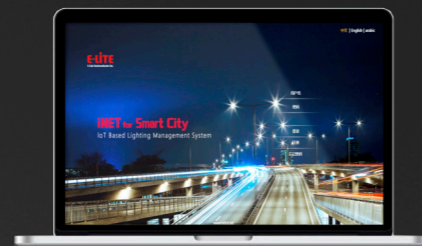



System & Hardwares



- 
Automatic Light On/Off & Dimming Control
 - By time setting
 - On/off or dimming with motion sensor detection
 - On/off or dimming with photocell detection

- 
Accurate Operation & Fault Monitor
 - Real-time monitor on each light - working status
 - Accurate report on fault detected
 - Provide location of fault, no patrol required
 - Collect each light operation data, such as voltage, current, power consumption

- 
Extra I/O Ports for Sensor Expandability
 - Environment Monitor
 - Traffic Monitor
 - Security Surveillance
 - Seismic Activities Monitor

- 
Reliable Mesh Network
 - Self proprietary wireless control node
 - Reliable node to node, gateway to node communication
 - Up to 1000 nodes per network
 - Max. network diameter 2000m

- 
Easy-to-use Platform
 - Easy monitor on each and all lights status
 - Support lighting policy remote set-up
 - Cloud server accessible from computer or hand held device

INSTALLATION

For high performance and long term reliability, the light should be installed in free air.

Slip Fitter Mount

1. Unlock the screws, adjust the angle of slip fitter.
2. Feed the power cord through the pole and make wiring.
3. Slide the fixture onto the pole, lock the screws.



Tempered Glass Cover

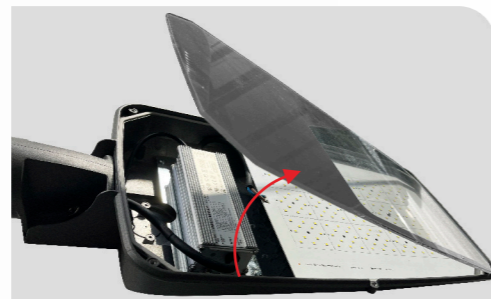

Driver Box

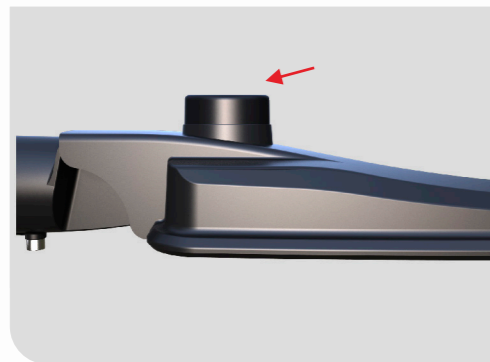

NEMA Sensor



Slip Fitter

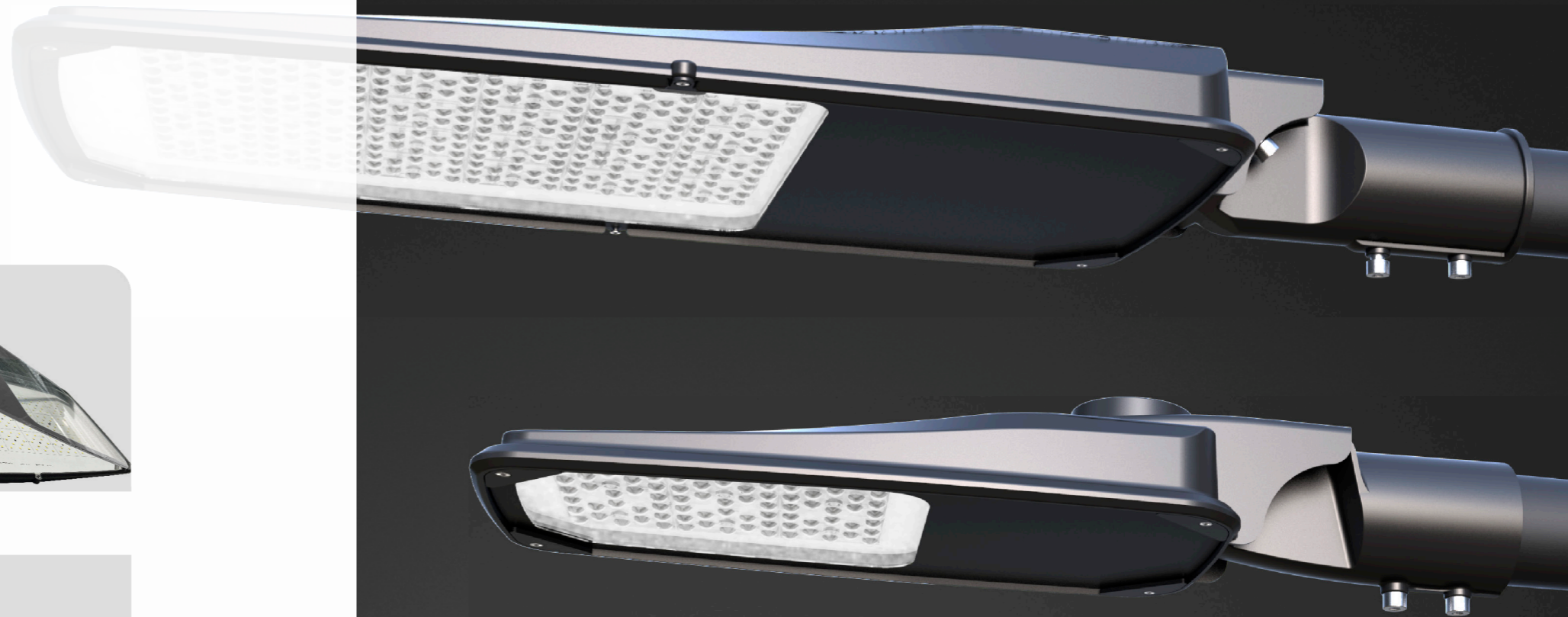

ORDERING INFORMATION

