

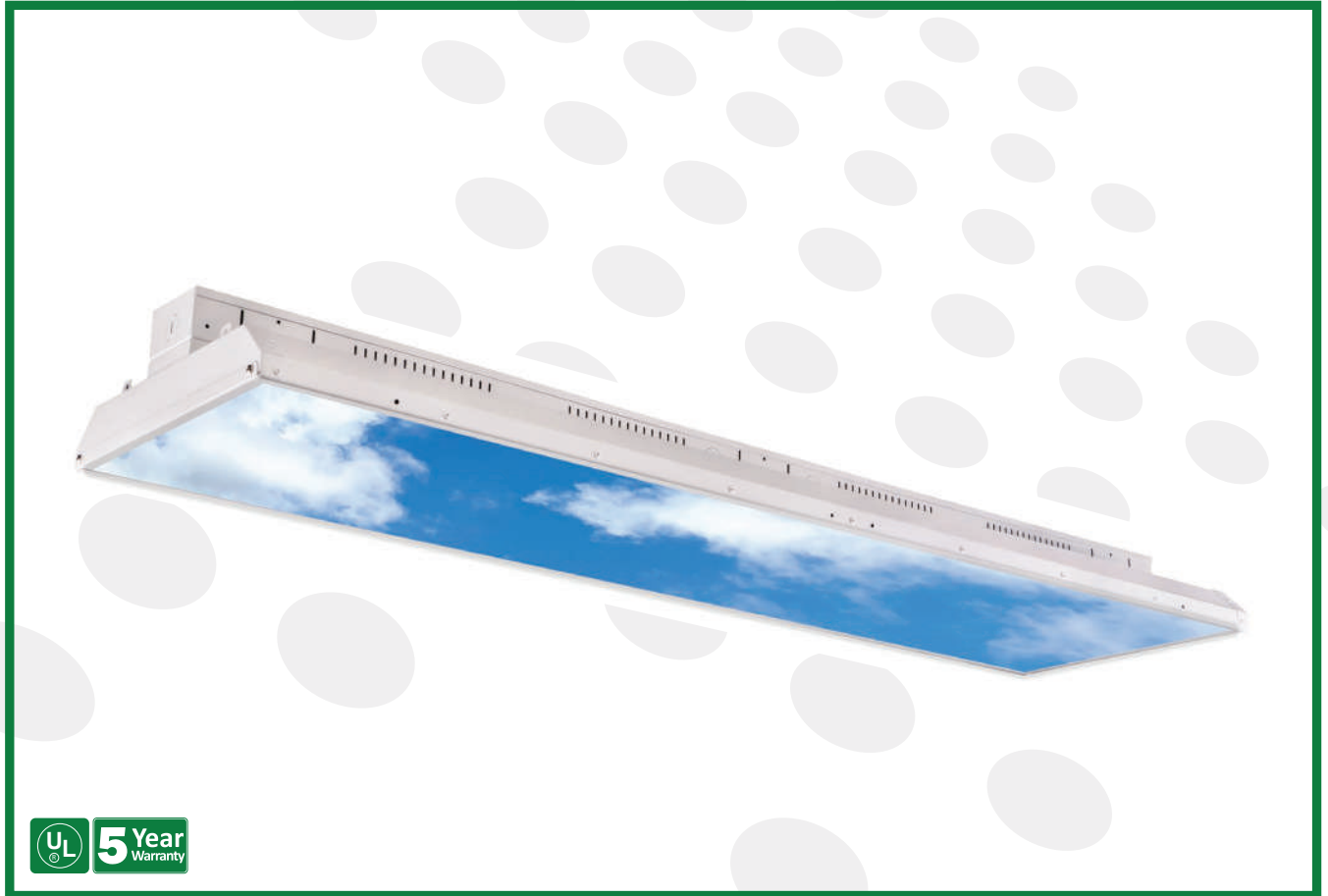

BILOXI™

CLOUD



The "Biloxi" High Bay from Beyond LED is the most innovative and revolutionary product of 2023. It enhances the aesthetically pleasing experience of the ceiling by providing a realistically close simulation of the natural sky in warehouses or high ceiling retail shops. Biloxi improves focus and concentration by reducing glare and providing uniform illumination. Its delivered lumens of 25000 are ideal for ceiling heights of up to 20 feet. Biloxi Luminaires are easy to install and come with a variety of mounting options. Biloxi luminaires are ideal for warehouses and high-end retail outlets. This UL certified High Bay has a 5-year warranty.

Product Features

- Ultra-thin Sleek Design
- Galvanized Steel with white paint
- PMMA Lens with customized cloud diffuser
- 1-10V Dimmable
- 320W with 25000 delivered lumens
- Standard Chain mount included
- Universal 120-277Vac
- UL Listed
- 5 years warranty.

BILOXITM

CLOUD



SKU #	Model #	Watt	Lumens	CCT	Size	Housing	Input Voltage	Dimming	Certifications
154303	BLT-PHB07-320WBF W1A1-WH65	320W	25000Lm	6500K	4ft	White	120V-277V	1-10V	UL

SKU Number 154303 Specifications

Parameter	Description	Value
General Performance	Model #	BLT-PHB07-320WBFW1A1-WH65
	Wattage	320W
	Lumen	25000LM
	Lumen Efficacy	Up to 81LM/W
	Color Temperature	6500K
	CRI (Ra)	>80
	Beam Angle	90° Degree
Electrical	Diffuser Type	PMMA Lens
	Input Voltage	120-277Vac
	Frequency	50/60Hz
	Dimming	1-10V
	Power Factor	≥0.9
	Driver Surge Protection	L-N : 2KV. L/N-PE : 4KV
Physical	Flicker Percent	No Flickering
	Operating Temperature	-40°C To 50°C
	Operating Humidity	20%-90%RH
	Storage Temperature	-40°C To 80°C
	Storage Humidity	10% - 95% RH
	LED Brand	Lumileds
	LED Type	SMD 2835 (0.5W)
	LED QTY	1215 PCS
	Housing	Lamp Body Material Galvanized Sheet
Housing Color	White	
Qualification	IP Rating	DAMP (IP20)
	Warranty	5 Years

LED LINEAR HIGH BAY



BILOXI™ CLOUD

Correlated Color Temperature (CCT)

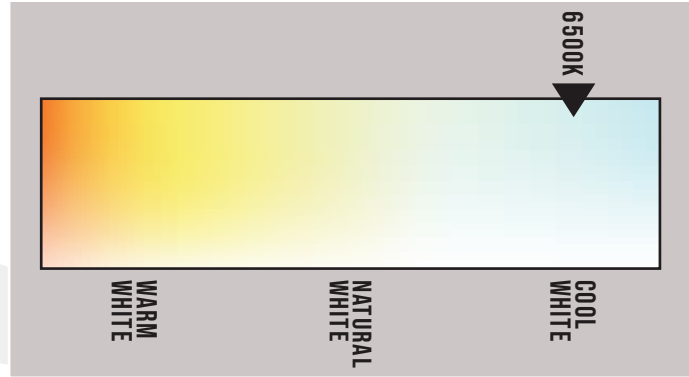

Dimensions

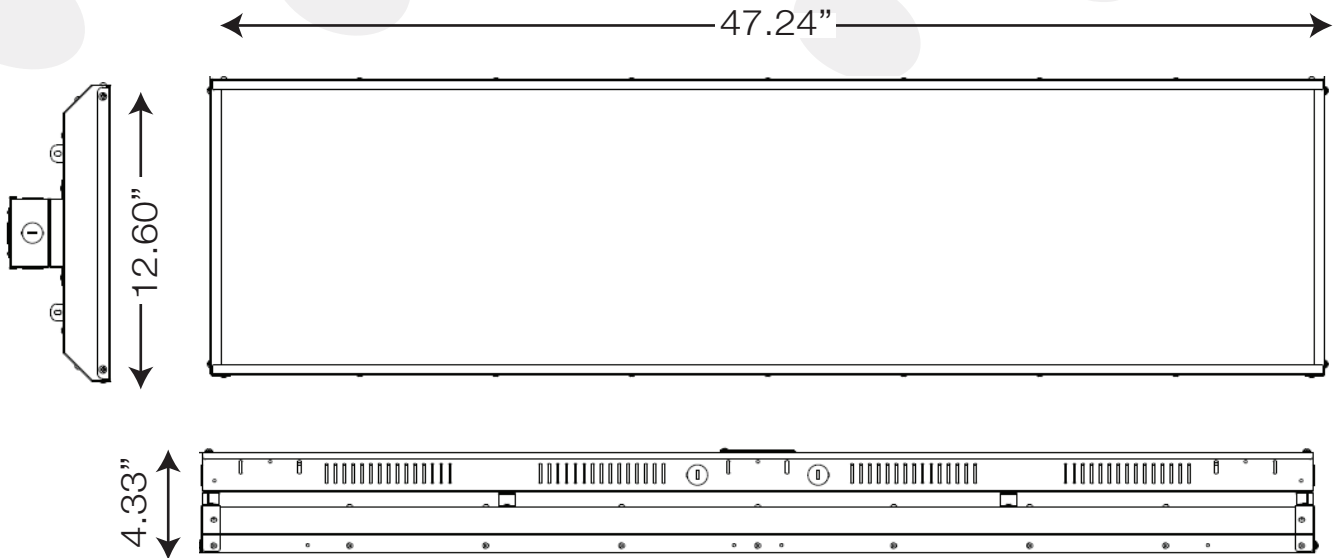

Accessories



Type A
Included



Type B
Optional



Type C
Optional

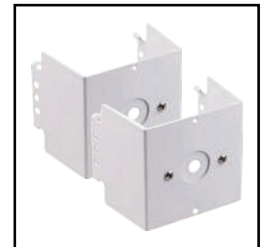

Type D
Optional



Photometric Result

Luminous Intensity Distribution Curve

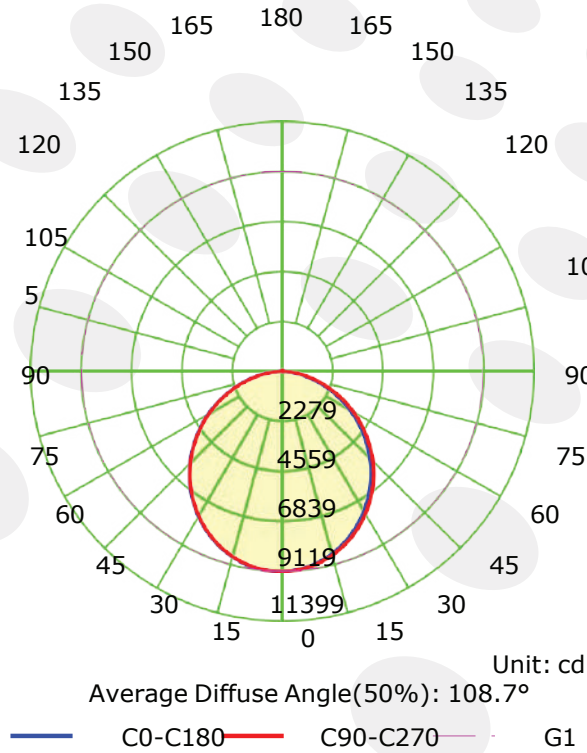

Luminous Intensity Distribution Curve

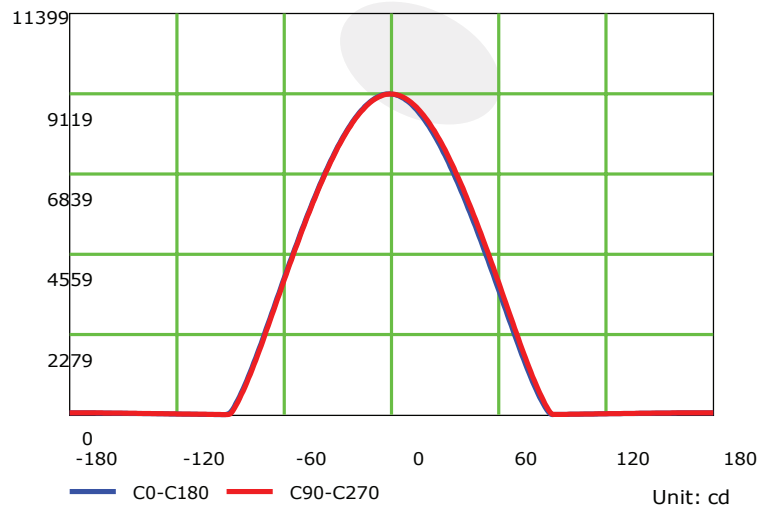
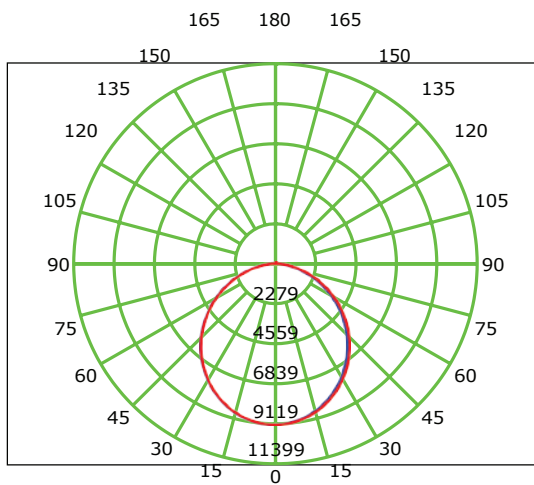



BILOXI™ CLOUD

Luminous Intensity Distribution Curve

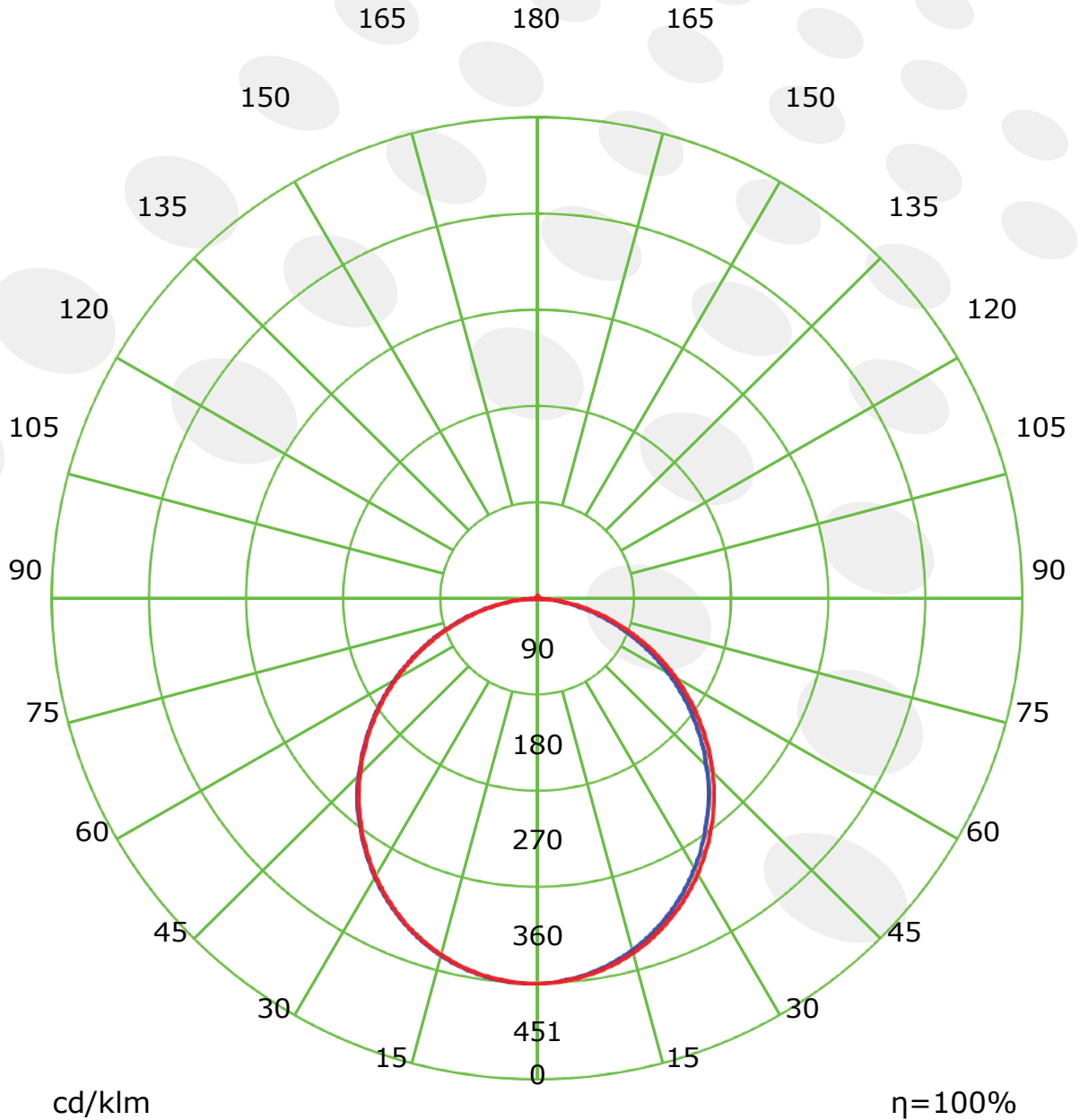

cd/klm

$\eta=100\%$

- C0-C180
- C90-C270

BILOXI™

CLOUD



Illuminance at a Distance(Beam Angle)

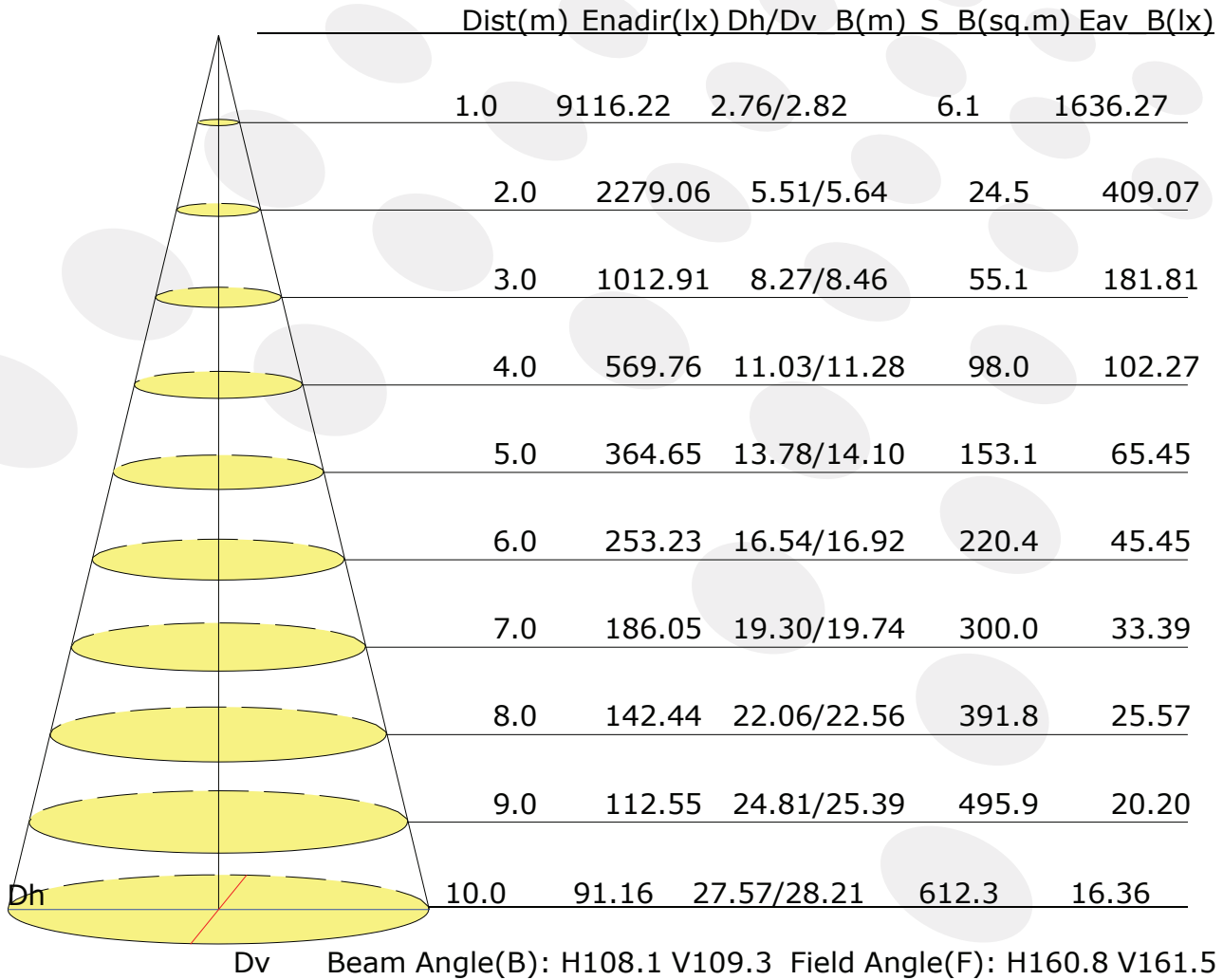

LED LINEAR HIGH BAY



BILOXI™

CLOUD

Illuminance at a Distance(Field Angle)

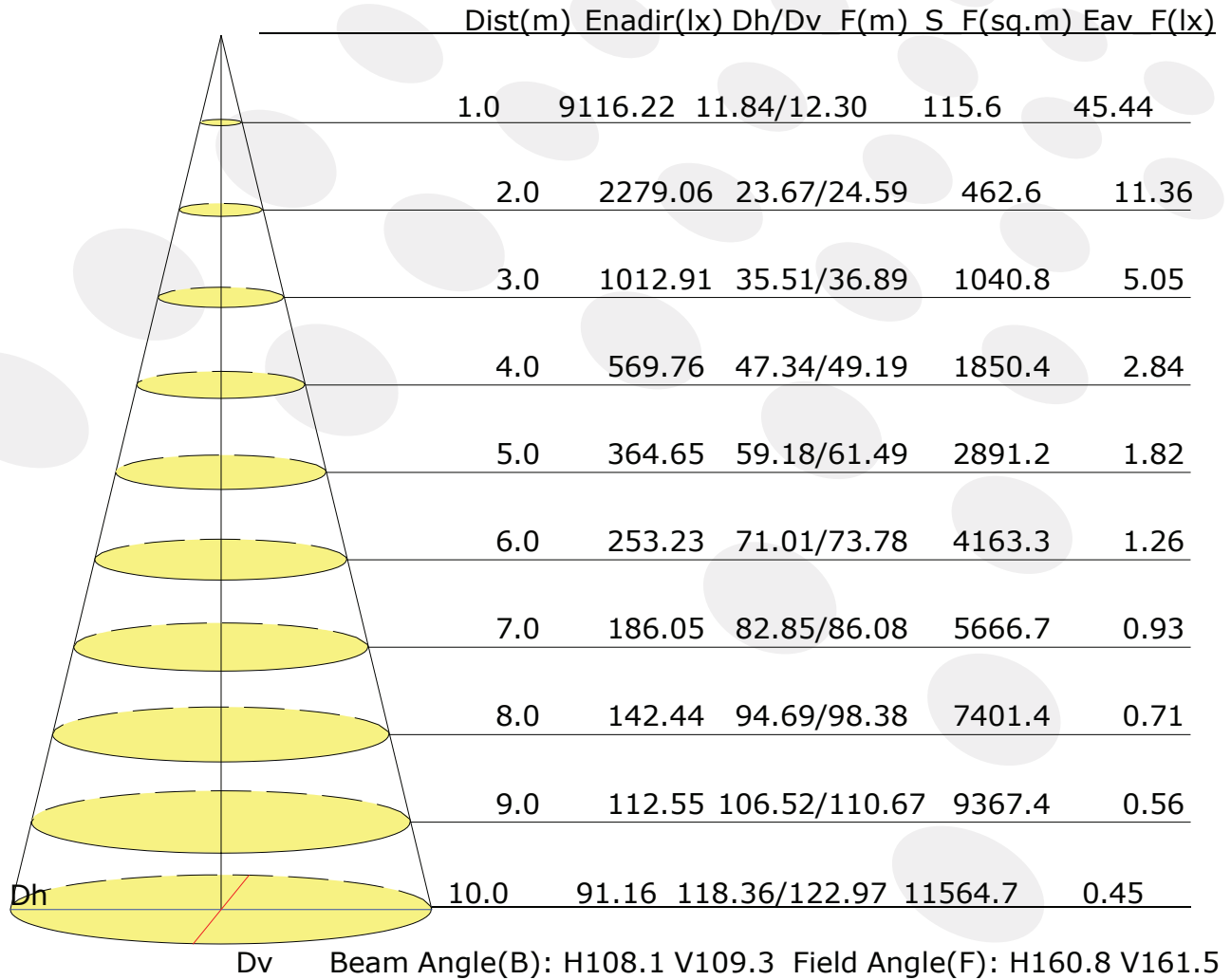



Area Flux Table

Area Flux Table

Unit: lm

-90	0.3	1.4	3.2	5.5	8.1	10.7	12.9	14.3	14.9	14.5	13.2	11.1	8.6	6.0	3.7	1.8	0.6	0.1	130.8	10.8
-80	0.6	3.3	8.6	16.1	25.0	34.2	42.4	48.3	51.3	50.7	46.7	39.9	31.3	22.1	13.6	6.7	2.1	0.2	443.0	392.3
-70	0.8	5.4	14.8	28.3	44.7	61.7	77.0	88.3	94.0	93.4	86.4	74.2	58.4	41.3	25.4	12.5	4.0	0.4	811.1	795.5
-60																				
-50	1.1	7.5	21.1	41.0	64.9	89.7	112.0	128.6	137.2	136.5	126.6	109.0	86.1	61.3	37.8	18.6	6.0	0.6	1185.4	1177.1
-40	1.3	9.6	27.1	52.8	83.7	115.8	144.6	166.3	177.6	176.9	164.2	141.5	112.1	80.0	49.5	24.3	7.8	0.8	1536.0	1530.5
-30	1.5	11.4	32.4	63.2	100.1	138.5	173.3	199.5	213.3	212.5	197.3	170.0	134.7	96.3	59.6	29.3	9.4	1.0	1843.3	1839.2
-20	1.7	12.8	36.7	71.5	113.2	156.8	196.4	226.5	242.3	241.5	224.2	193.1	152.9	109.1	67.4	33.2	10.7	1.1	2091.0	2087.7
-10	1.8	13.8	39.6	77.2	122.4	169.6	212.8	245.6	262.8	261.9	243.2	209.3	165.2	117.4	72.4	35.8	11.6	1.2	2263.0	2260.6
0	1.9	14.4	41.1	80.2	127.1	176.2	221.1	255.4	273.3	272.4	252.3	216.3	170.2	120.9	74.6	36.9	12.0	1.3	2347.0	2344.6
10	1.9	14.3	41.0	79.8	126.5	175.4	220.0	254.2	272.6	271.7	251.2	215.2	169.4	120.4	74.3	36.8	11.9	1.3	2337.0	2334.9
20	1.8	13.7	39.1	76.1	120.6	167.1	210.2	243.6	261.4	260.6	241.4	207.0	163.1	115.9	71.6	35.4	11.5	1.2	2241.0	2238.3
30	1.7	12.5	35.8	69.7	110.5	153.9	193.7	224.1	240.3	239.6	222.2	190.9	150.5	107.0	66.0	32.6	10.5	1.1	2062.0	2059.3
40	1.5	11.0	31.3	61.0	97.4	135.6	170.4	196.9	210.9	210.3	195.2	167.9	132.5	94.2	57.9	28.5	9.2	1.0	1812.0	1808.3
50	1.3	9.1	25.8	50.5	81.0	112.9	141.7	163.6	175.1	174.5	162.1	139.4	110.1	78.0	47.8	23.4	7.5	0.8	1504.0	1498.9
60	1.0	7.1	19.7	38.8	62.3	86.8	109.1	125.9	134.6	134.2	124.5	107.0	84.2	59.5	36.3	17.6	5.6	0.6	1154.0	1145.5
70	0.8	4.9	13.4	26.3	42.3	59.0	74.2	85.6	91.5	91.1	84.3	72.3	56.6	39.8	24.1	11.6	3.7	0.4	782.0	764.2
80	0.5	2.9	7.4	14.4	22.9	31.8	39.9	46.0	49.0	48.7	44.8	38.3	29.8	20.8	12.5	6.0	1.8	0.2	417.0	358.7
	0.3	1.0	2.3	4.2	6.6	8.9	11.0	12.5	13.2	13.0	11.8	10.0	7.6	5.2	3.1	1.4	0.4	0.1	112.8	1.1



BILOXI™

CLOUD

UGR Table

Reflectance:										
Ceiling (cavity)	0.7	0.7	0.5	0.5	0.3	0.7	0.7	0.5	0.5	0.3
Wall	0.5	0.3	0.5	0.3	0.3	0.5	0.3	0.5	0.3	0.3
Reference plane	0.2	0.2	0.2	0.2	0.2	0.2	0.2	0.2	0.2	0.2
Room dimensions	Viewed crosswise					Viewed endwise				
X=2H Y=2H	23.3	24.7	23.6	24.9	25.2	23.6	24.9	23.9	25.2	25.4
3H	24.8	26.0	25.1	26.3	26.6	25.1	26.3	25.4	26.6	26.9
4H	25.3	26.5	25.7	26.8	27.1	25.7	26.9	26.1	27.2	27.5
6H	25.7	26.8	26.1	27.1	27.4	26.2	27.3	26.5	27.6	27.9
8H	25.8	26.9	26.2	27.2	27.5	26.3	27.4	26.7	27.7	28.0
12H	25.8	26.9	26.2	27.2	27.6	26.4	27.4	26.8	27.8	28.1
X=4H Y=2H	24.0	25.2	24.4	25.5	25.8	24.2	25.4	24.5	25.7	26.0
3H	25.6	26.7	26.0	27.0	27.4	25.9	26.9	26.3	27.3	27.6
4H	26.3	27.2	26.7	27.6	28.0	26.6	27.6	27.1	27.9	28.3
6H	26.8	27.6	27.2	28.0	28.4	27.2	28.0	27.7	28.4	28.8
8H	27.0	27.7	27.4	28.1	28.6	27.4	28.2	27.9	28.6	29.0
12H	27.1	27.7	27.5	28.2	28.6	27.6	28.2	28.0	28.7	29.1
X=8H Y=4H	26.6	27.4	27.1	27.8	28.2	26.9	27.7	27.4	28.1	28.5
6H	27.3	27.9	27.7	28.3	28.8	27.6	28.2	28.1	28.7	29.2
8H	27.5	28.0	28.0	28.5	29.0	27.9	28.4	28.4	28.9	29.4
12H	27.6	28.1	28.1	28.6	29.1	28.1	28.6	28.6	29.1	29.6
X=12H Y=4H	26.6	27.3	27.1	27.7	28.2	26.9	27.6	27.4	28.0	28.5
6H	27.3	27.8	27.8	28.3	28.8	27.7	28.2	28.2	28.7	29.2
8H	27.6	28.0	28.1	28.5	29.1	28.0	28.5	28.5	29.0	29.5
Variations with the observer position at spacings:										
S=1.0H	+0.2/-0.2					+0.2/-0.1				
S=1.5H	+0.4/-0.5					+0.3/-0.4				
S=2.0H	+0.5/-0.9					+0.5/-0.8				

BILOXI™

CLOUD



LCS Graph

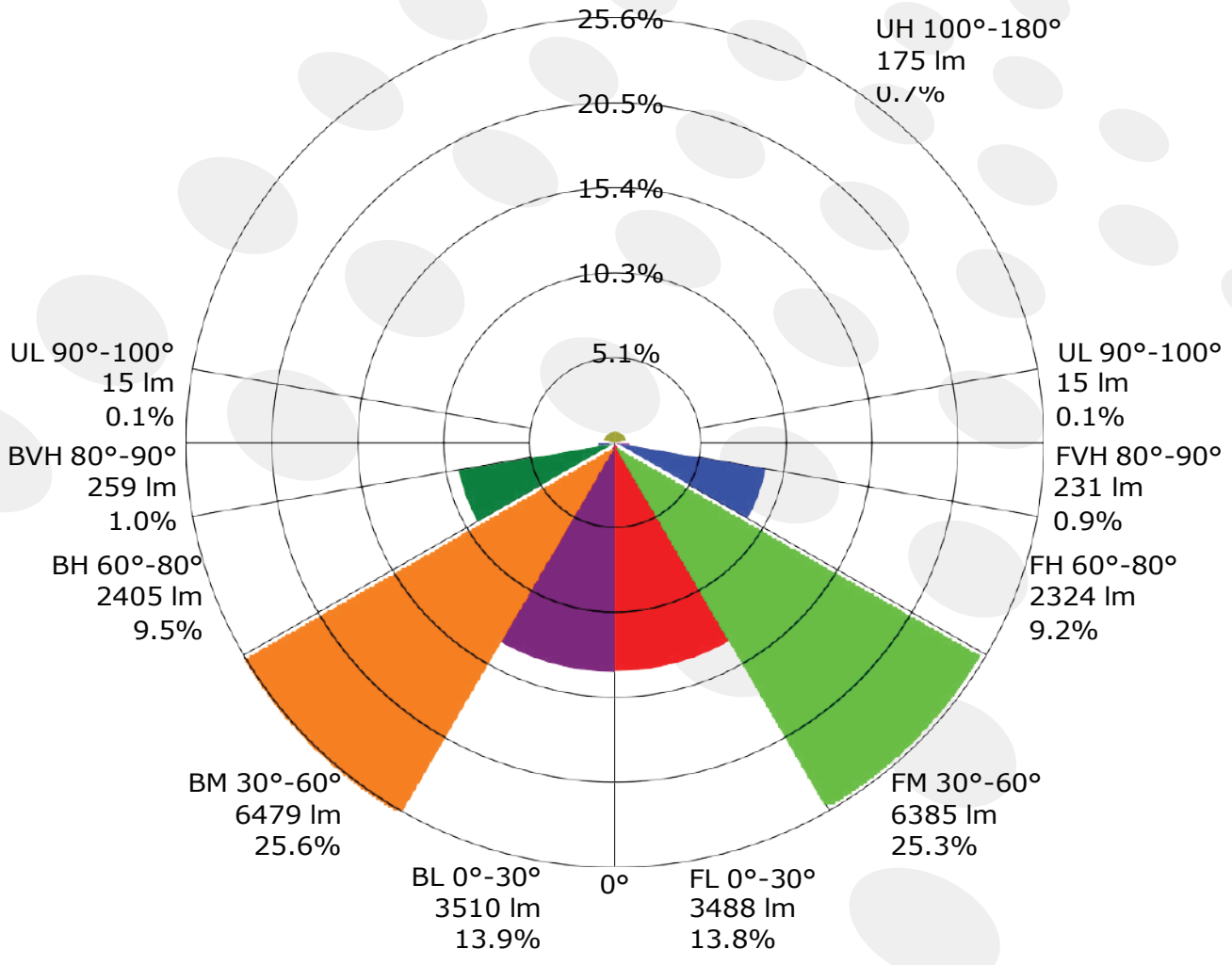

Back Light

Forward Light

Scale= MAX LCS%

Trapped Light: NA,NA

LED LINEAR HIGH BAY



BILOXI™

CLOUD

INSTALLATION INSTRUCTIONS

Possible maximum product weight (when specific mounts or function was chosen)

Power	Weight	Product Dimension
90W	7KG	630x320mm
110W	7KG	630x320mm
135W	7KG	630x320mm
165W	8KG	630x420mm
180W	8.5KG	630x420mm
215W	9KG	630x420mm
215W	9.5KG	900x320mm
320W	11.5KG	1200x320mm

Warning / Avertissement

MIN 90°C SUPPLY CONDUCTORS

THIS PRODUCT MUST BE INSTALLED IN ACCORDANCE WITH THE APPLICABLE INSTALLATION CODE BY A PERSON FAMILIAR WITH THE CONSTRUCTION AND OPERATION OF THE PRODUCT AND THE HAZARDS INVOLVED

CONSULT A QUALIFIED ELECTRICIAN TO ENSURE CORRECT BRANCH CIRCUIT CONDUCTOR

LES FILS D'ALIMENTATION 90 °C MIN

**CE PRODUIT DOIT ÊTRE INSTALLÉ SELON LE CODE D'INSTALLATION PERTINENT, PAR UNE PERSONNE QUI CONNAÎT BIEN LE PRODUIT ET SON FONCTIONNEMENT AINSI QUE LES RISQUES INHÉRENTS
CONSULTER UN ÉLECTRICIEN QUALIFIÉ POUR VOUS ASSURER QUE LES CONDUCTEURS DE LA DÉRIVATION SONT ADÉQUATS**



INSTALLATION INSTRUCTIONS

Cautions:

1. Can not use the electric generator to test the LED lamp.
2. Please abide by related country, regional and local law and regulations when install this fixture.
3. Please turn off the power before installation or maintenance.
4. Proper earth grounding is required to ensure safety.

Notice:

1. To avoid possibility of electrical shock or fire, the installation personnel must have professional electric knowledge.
2. Please wear gloves to avoid injury before installation.
3. If any smoke or spark of the wire happened, please turn off the power immediately and notify relevant personnel.

Attention:

1. Please check if there is any damage during shipping. If so, please contact manufacturer timely.
2. Please read the installation instruction carefully to check whether all the accessories are complete. After confirmation, then install the fixture according to installation steps.

Wiring Diagram & Instruction:

3 dimming functions are available in this high bay light:

1. Constant current can be achieved by 1-10VDC dimming.
2. PWM signal dimming.
3. Variation of resistance unit dimming.

Wiring Instruction

L:Black

N:White

⊕ : Green/Yellow

+DIM: Purple

- DIM: Grey

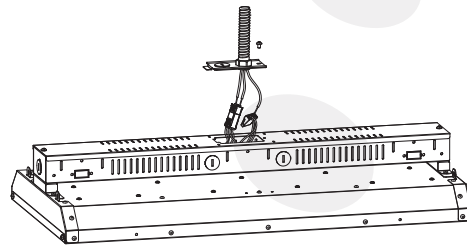

Please choose the appropriate dimming way according to your needs. You can also choose not to use this function.

*The product can not be connected to a dimming device when it's equipped with Motion ensor.

Three Installation: Chain/Cable Installation, 3/4" NPT Installation, Surface Mounting/Pendent Mounting

(Please choose the most suitable installation method for the urchased product as per your needs)

A.Hanging Installation: (Chain/Cable)

Step1.Hook up the chain: (Figure 1)

Step2.Connect the chain with fixture: (Figure 1)

Step3. Fix the chain on the rail, adjust the chain length as per need: (Figure 1)

Step4.After the fixing , choose suitable wiring knock out, do wiring according to local standard and code(Two different wiring methods for this installation).

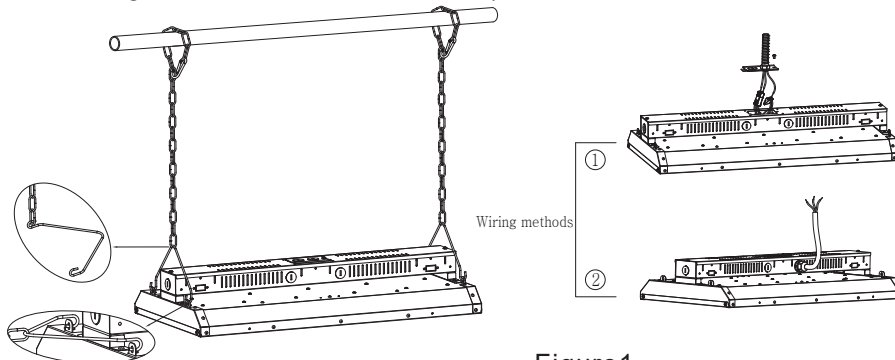

Figure1



BILOXI™

CLOUD

INSTALLATION INSTRUCTIONS

B. 3/4" NPT Installation:

- Step1. Mount the bracket on 3/4" NPT (Figure 2);
- Step2. Lock fixture on the bracket (Figure 3);
- Step3. Do wiring according to local standard and code.
- Step4. Lock side brackets with screw driver (Figure 4).



Figure2

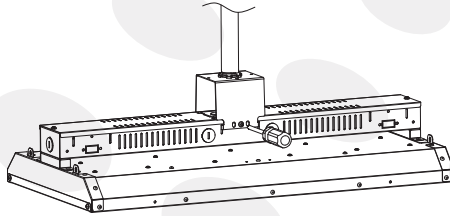

Figure3

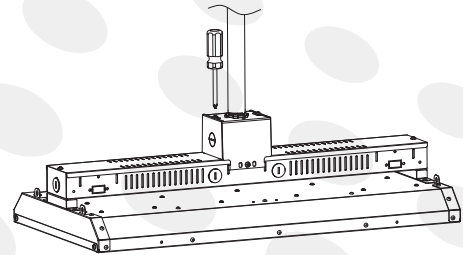

Figure4

C. Surface Mounting/ Pendant Mounting:

- Step1. Mount the bracket on the rail or ceiling (Figure 5)
- Step2. Mount bolt on the rail or ceiling, and mount the fixture bracket on the bolt (Figure 6); and then install the fixture. (Figure 7).
- Step3. After mounting, choose suitable wiring knock out and do wiring according to local.

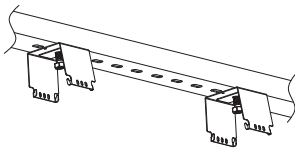

Figure5

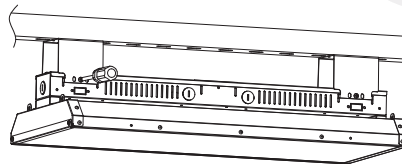

Figure6

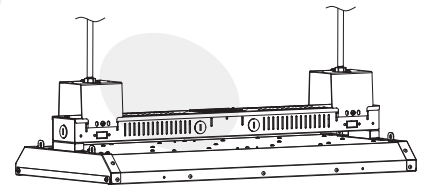

Figure7

Extra Accessory Option Installation: 1: Wire Guard, 2: Motion Sensor/PIR Sensor, 3: Backup driver.

1. Wire Guard: (Purchase the correct size wire guard from manufacturer)

- Step1. Mount the wire guard on the fixture with screws (Figure 8)

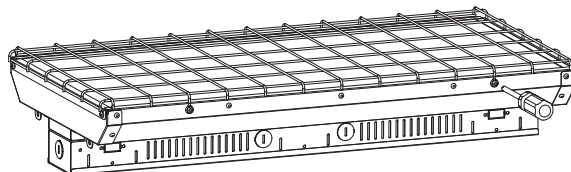

Figure8



INSTALLATION INSTRUCTIONS

2. Motion Sensor /PIR Sensor:(Both sensor are with same installation)

Step1. Open the driver cover plate with a screwdriver (Figure 9)

Step2. Knock out the side cover, mount the sensor on the side, do wiring accoing to instruction on sensor (Figure 10).Step3. Fix the driver cover plate back in place (Figure 11).

Wiring Instruction

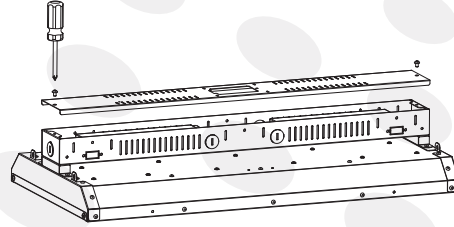
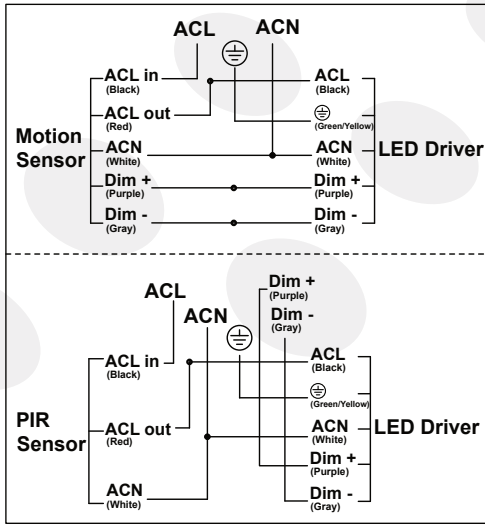

Figure9

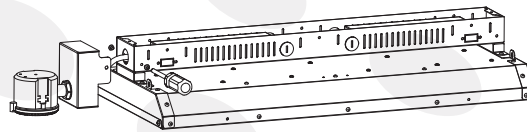

Figure10

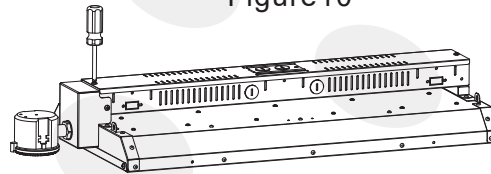
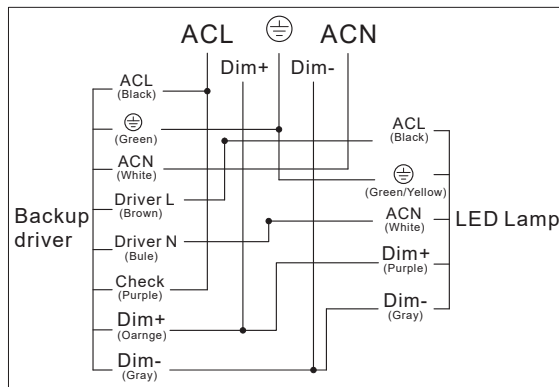

Figure11

3. Backup driver is a Listed emergency driver and needs a professional electrician to install according to NEC. rule and applicable installation code. And the below wiring is for reference.

Wiring Instruction





BILOXI™

CLOUD

Package

Box Type	Box Dimension	Qty / Carton	Net Weight / Carton	Gross Weight / Carton
Outer box	50.78 x 14.96 x 6.69	1PC	19.40 LBS	24.25 LBS
Outer box (Sensor)	55.31 x 14.96 x 6.69	1PC	20.50 LBS	25.79 LBS

Application Pictures



Warranty

5 Years Warranty