



ZOHO™

4th Gen. Premium



The ZOHO 4th Generation Premium Edition Area Light is included amongst Beyond LED Technology's best-selling products, with over 200,000 pieces sold in the last three years. The ZOHO 4th Generation Area Light offers high efficacy, with up to 170 lumens per watt for maximum power savings, and rebates from power companies. These Area Lights have a new heat sink design that ensures a longer lifespan for the products. These products are a perfect solution primarily for outdoor applications such as lighting parking areas, loading docks and other general lighting applications.

Product Features

- Up to 170 Lumens per watt
- Operating temperature: -40°C to 45°C
- 0-10V Dimming capability
- Optional 3 pin screw-in photocell
- Built-in 10KV Surge protector
- Multiple bracket options
- Ultra-thin sleek design
- This product is IP65 rated
- High efficacy Bridgelux 3030 Chips
- Input Voltage 120-277Vac / 277-480Vac
- Heat resistant polycarbonate optical lens
- Die-cast aluminium housing
- Spotless soft light without shadow
- No UV or IR in the beam
- Environment friendly with no mercury
- Easy to install and operate, with instant startup and no humming
- UL & DLC approved

ZOHO™

4th Gen. Premium



SKU #	Model #	Watt	Lumens	CCT	IP	Housing	Input Voltage	Dimming	Certifications
155944	BLT-S-GB-150WJ30T3A5-BH10SP5	150W	25389Lm	5000K	IP65	Black	100V-277V	0-10V	UL & DLC
153505	BLT-S-GB-150WJ30T3A6-GR10SP50	150W	25389Lm	5000K	IP65	Grey	100V-277V	0-10V	UL & DLC
154192	BLT-S-GB-150WJ30T3A6-BR10SP50	150W	25389Lm	5000K	IP65	Bronze	100V-277V	0-10V	UL & DLC
155448	BLT-S-GB-150WJ30T3A6-BR10SP50	150W	25389Lm	5000K	IP65	Bronze	240V-480V	0-10V	UL & DLC
154193	BLT-S-GB-240WJ30T3A5-BR10SP50	240W	41404Lm	5000K	IP65	Bronze	100V-277V	0-10V	UL & DLC
153509	BLT-S-GB-300WJ3030T3H2-BH10SP50	300W	50802Lm	5000K	IP65	Bronze	277V-480V	0-10V	UL & DLC
154101	BLT-S-GB-300WJ30T3A5-BR10SP50	300W	49795Lm	5000K	IP65	Bronze	100V-277V	0-10V	UL & DLC
153507	BLT-S-GB-300WJ30T3A5-GR10SP50	300W	49795Lm	5000K	IP65	Grey	100V-277V	0-10V	UL & DLC
154100	BLT-S-GB-300WJ30T3A5-BH10SP50	300W	49795Lm	5000K	IP65	Black	100V-277V	0-10V	UL & DLC

Optional Photocell



SKU #. 110786

Universal Bracket



SKU #. 151592 (Black)
 SKU #. 152378 (Bronze)
 SKU #. 153513 (Grey)

Yoke Mount

SKU #. 151593 (Black)
 SKU #. 152379 (Bronze)
 SKU #. 153514 (Grey)



LED AREA LIGHT



ZOHO™

4th Gen. Premium

Specifications

Parameter	Description	Value
General Performance	Wattage	150W
	Lumen	Up to 25389LM
	Lumen Efficacy	Up to 172LM/W
	Color Temperature	5000K
	CRI (Ra)	>70
	Beam Angle	140 * 100 Degree
	Distribution Pattern	Type III
Electrical	Input Voltage	100-277Vac / 240-480Vac
	Frequency	50/60Hz
	Dimming	0-10V Dimming Standard
	PF	≥0.9
	Driver	MP-150TG130A
	Surge Protector	Driver surge protection: L/N-PE: 6kV, L-N: 6kV with extra 10KV Surge protector
Physical	Operating Temperature	-40°C TO 45°C
	Storage Temperature	-40°C TO 80°C
	Operating Humidity	10% - 90% RH
	Storage Humidity	10% - 95% RH
	LED Brand	Bridgelux
	LED Type	SMD3030
	LED QTY	300PCS
	Housing	Aluminium Alloy
Qualification	Housing Color	Black / Grey / Bronze
	IP Rating	IP65
	Warranty	5 years warranty with 24/7 operating hours Luminaire lifetime at 25°C



Specifications

Parameter	Description	Value
General Performance	Model #	BLT-S-GB-240WJ30T3A5-BR10SP50
	Wattage	240W
	Lumen	Up to 41404LM
	Lumen Efficacy	Up to 171LM/W
	Color Temperature	5000K
	CRI (Ra)	>70
	Beam Angle	140 * 100 Degree
	Distribution Pattern	Type III
Electrical	Input Voltage	100-277Vac
	Frequency	50/60Hz
	Dimming	0-10V dimming standard
	PF	≥0.9
	Driver	Non-Isolated
	Surge Protector	Driver surge protection: L/N-PE: 6kV, L-N: 6kV with extra 10KV Surge protector
Physical	Operating Temperature	-40°C TO 45°C
	Storage Temperature	-40°C TO 80°C
	Operating Humidity	10% - 90% RH
	Storage Humidity	10% - 95% RH
	LED Brand	Bridgelux
	LED Type	SMD3030
	LED QTY	508 Pcs / 600 pcs
	Housing	Aluminium Alloy
Qualification	Housing Color	Bronze
	IP Rating	IP65
	Warranty	5 years warranty with 24/7 operating hours Luminaire lifetime at 25°C



ZOHO™

4th Gen. Premium

Specifications

Parameter	Description	Value
General Performance	Model #	BLT-S-GB-300WJ3030T3H2-BR10SP50
	Wattage	300W
	Lumen	Up to 50803LM
	Lumen Efficacy	Up to 171LM/W
	Color Temperature	5000K
	CRI (Ra)	>70
	Beam Angle	140 * 100 Degree
	Distribution Pattern	Type III
Electrical	Input Voltage	277-480Vac
	Frequency	50/60Hz
	Dimming	0-10V dimming standard
	PF	≥0.9
	Driver	Non-Isolated
	Surge Protector	Driver surge protection: L/N-PE: 6kV, L-N: 6kV with extra 10KV Surge protector
Physical	Operating Temperature	-40°C TO 45°C (With Motion Sensor -35°C TO 45°C)
	Storage Temperature	-40°C TO 80°C
	Operating Humidity	10% - 90% RH
	Storage Humidity	10% - 95% RH
	LED Brand	Bridgelux
	LED Type	SMD3030
	LED QTY	616 Pcs
	Housing	Aluminium Alloy
Qualification	Housing Color	Bronze
	IP Rating	IP65
	Warranty	5 years warranty with 24/7 operating hours Luminaire lifetime at 25°C



Specifications

Parameter	Description	Value
General Performance	Model #	BLT-S-GB-300WJ30T3A5-BH10SP50
	Wattage	300W
	Lumen	Up to 49795LM
	Lumen Efficacy	Up to 172LM/W
	Color Temperature	5000K
	CRI (Ra)	>70
	Beam Angle	140 * 100 Degree
	Distribution Pattern	Type III
Electrical	Input Voltage	100-277Vac
	Frequency	50/60Hz
	Dimming	0-10V dimming standard
	PF	≥0.9
	Driver	MP-150TG130A*2
	Surge Protector	Driver surge protection: L/N-PE: 6kV, L-N: 6kV with extra 10KV Surge protector
Physical	Operating Temperature	-40°C TO 45°C
	Storage Temperature	-40°C TO 80°C
	Operating Humidity	10% - 90% RH
	Storage Humidity	10% - 95% RH
	LED Brand	Bridgelux
	LED Type	3030
	LED QTY	600 Pcs
	Housing	Aluminium Alloy
Qualification	Housing Color	Grey / Bronze / Black
	IP Rating IP65	IP65
	Warranty	5 years warranty with 24/7 operating hours Luminaire lifetime at 25°C



ZOHO™

4th Gen. Premium

Correlated Color Temperature (CCT)

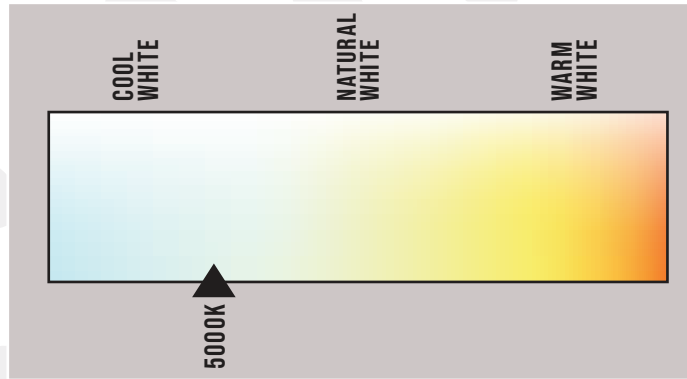

Dimensions

Universal Mount

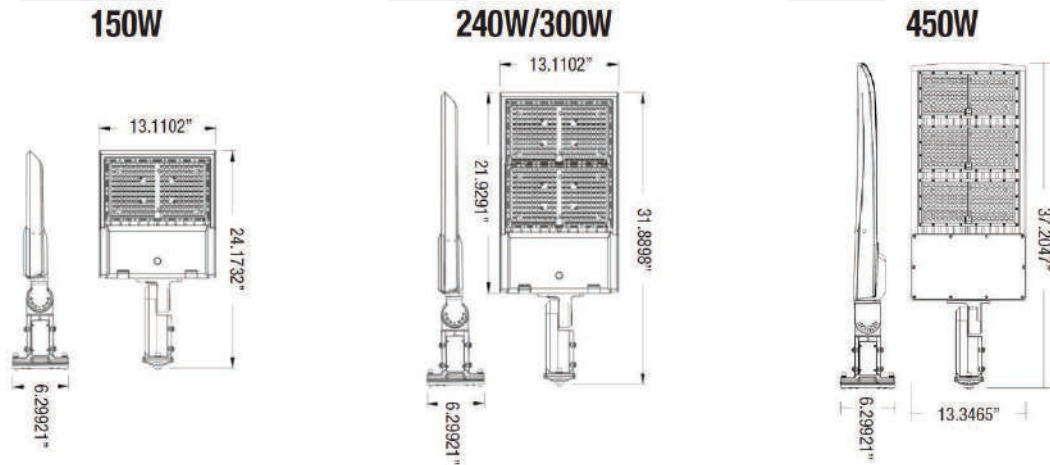

Dimensions

Yoke Mount

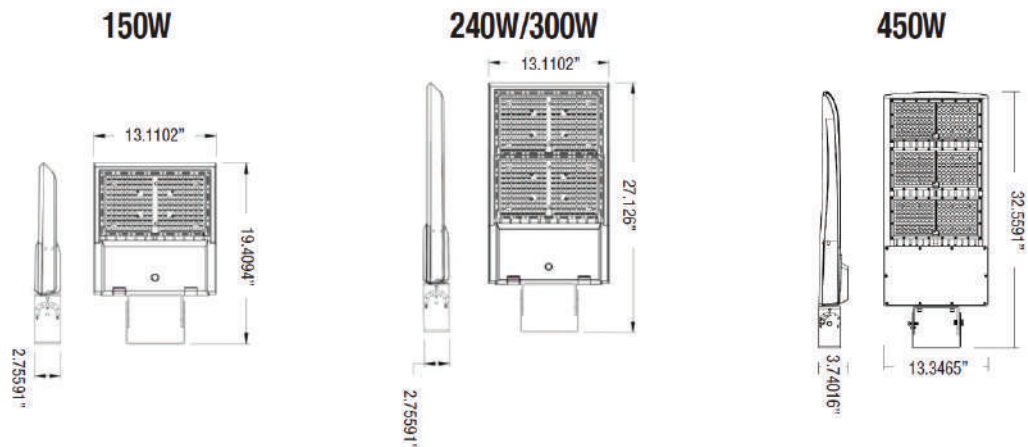



Photometric Data for SKU Number 153505

Luminous Intensity Distribution Curve

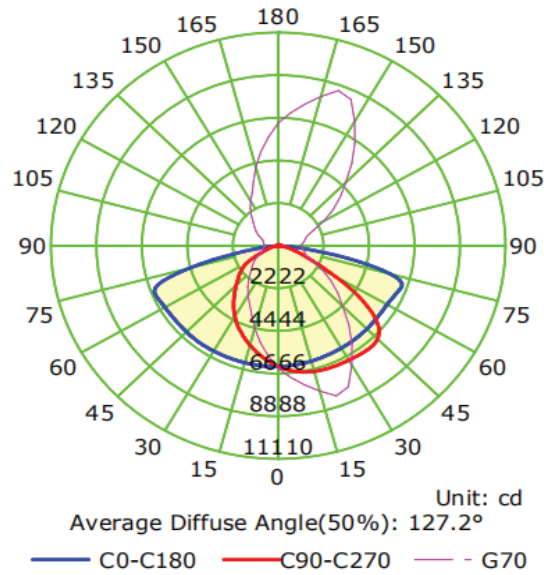

Illuminance at a Distance

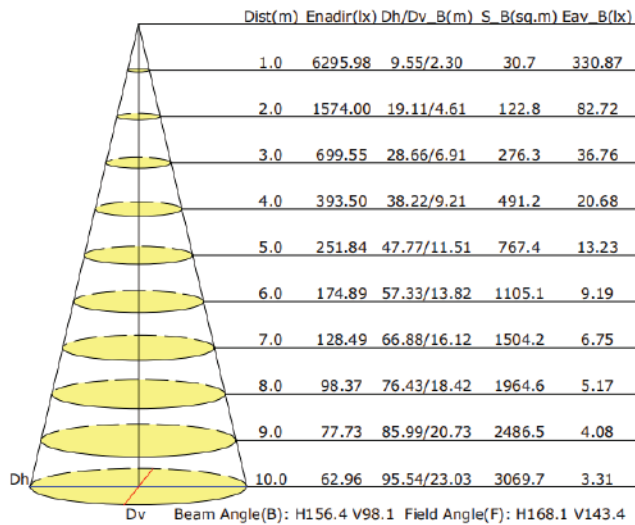



ZOHO™

4th Gen. Premium

Photometric Data for SKU Number 153507

Luminous Intensity Distribution Curve

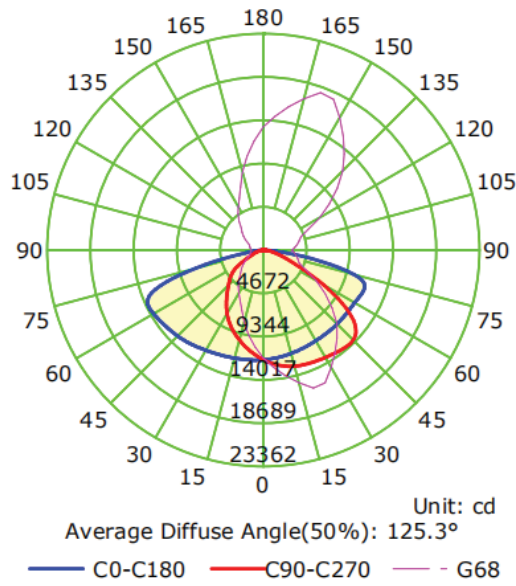

Illuminance at a Distance

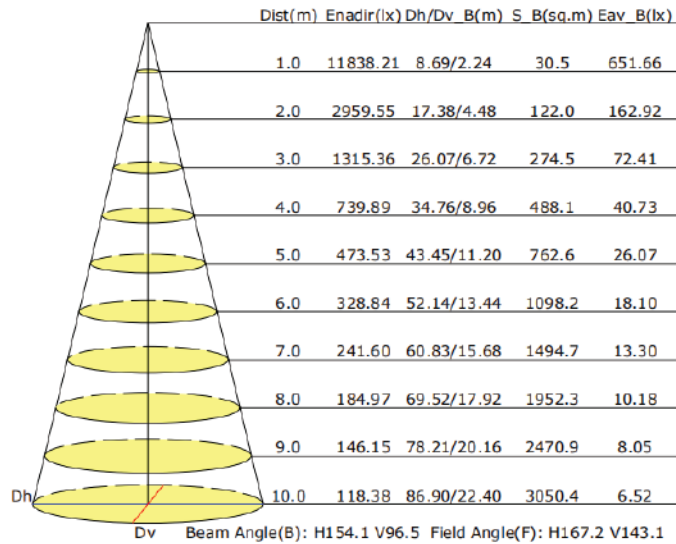



Installation

Cautions:

1. Can not use the electric generator to test the LED lamp.
2. Please abide by related country, regional and local law and regulations when install this fixture.
3. To avoid electrical shock and damage, please do not install the lights in raining days.

Notices:

1. To prevent from electric shock or fire risk, the installation must be conducted by operator who have professional electrical knowledge.
2. Please wear gloves to avoid injury before installing lamps.
3. During or after installation, if there are situations such as smoke, fire in the wires or lamps, please turn off the power immediately and notify relevant personnel of an overhaul.
4. This light can be used for outdoor installation.

Instructions:

1. This product has dimming and non-dimming function, which differs in installation ways.
2. 3 dimming functions are available in this shoebox light:
 - (1). Constant current can be achieved by 1-10VDC dimming.
 - (2). PWM signal dimming.
 - (3). Variation of resistance unit dimming(Please choose the appropriate dimming way according to your needs. You can also choose not to use this function).
3. Choose the wire connection ways, dimming ways and installation ways according to your needs and the led fixture purchased.

Wiring Diagram:

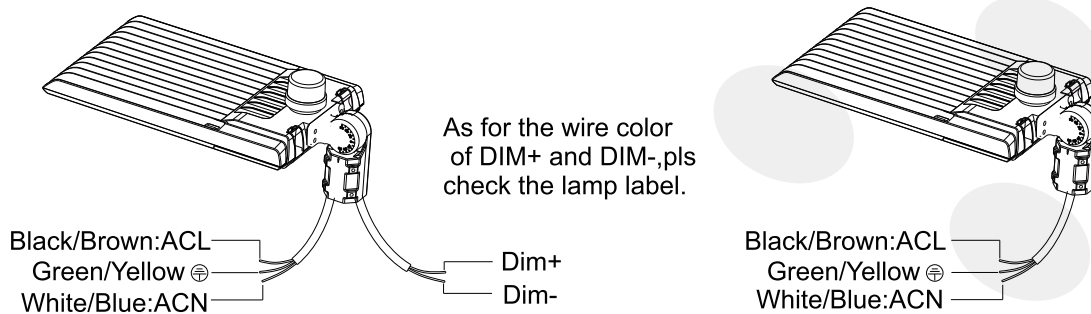

Optional Brackets and Installation Instructions

There are 5 optional brackets for this fixture. The following is shoebox fixtures with different brackets

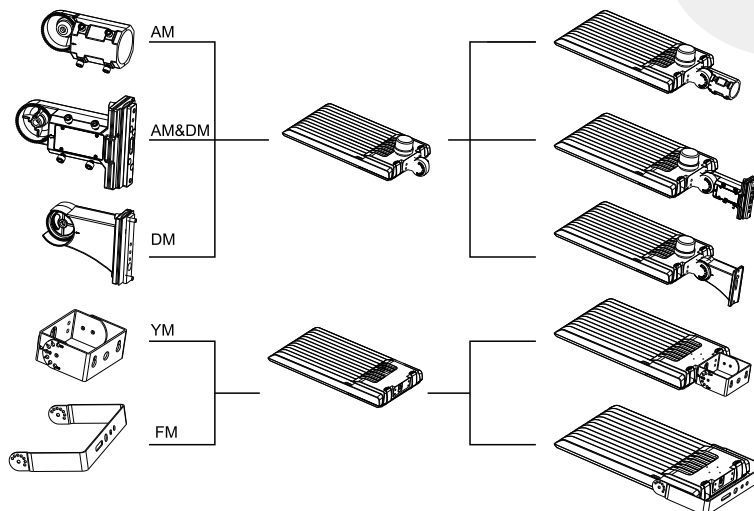



Installation

Installation Instructions with different brackets:

1. ADJUSTABLE FITTER MOUNTING (AM)

Step 1: Remove the bracket mounting screws on the fixture and run the wires through the bracket. (Figure 1)

Step 2: Install the bracket on the fixture. (Figure 2)

2. ADJUSTABLE FITTER MOUNTING & DIRECT MOUNTING (AM&DM)

Step 1: Remove the bracket mounting screws on the fixture, open the side lid of bracket and run the wires through the bracket. (Figure 3)

Step 2: Install the bracket on the fixture, then cover the side lid and tighten it. (Figure 4)

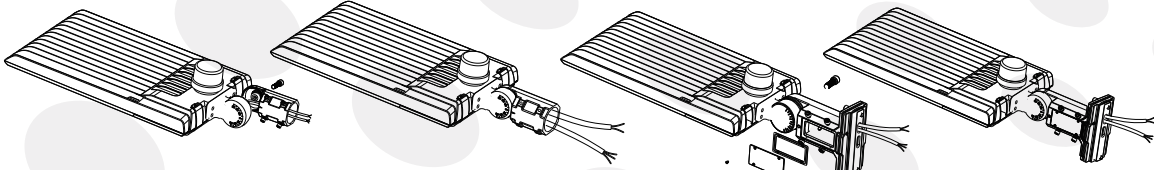

Figure 1

Figure 2

Figure 3

Figure 4

3. DIRECT MOUNTING (DM)

Step 1: Remove the bracket mounting screws on the fixture, open the side lid of bracket and run the wires through the bracket. (Figure 5)

Step 2: Install the bracket on the fixture, then cover the side lid and tighten it. (Figure 6)

4. YOKE MOUNTING (YM)

Step 1: Remove the bracket mounting screws on the fixture and run the wires through the bracket. (Figure 7)

Step 2: Install the bracket on the fixture. (Figure 8)

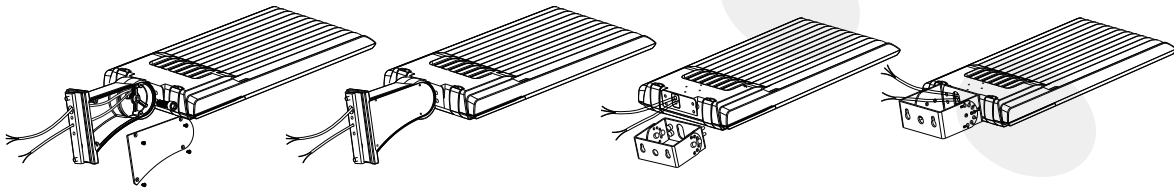

Figure 5

Figure 6

Figure 7

Figure 8

5. FLOOD MOUNTING (FM)

Step 1: First install two big screwst. (Figure 9)

Step 2: Install two small screws. (Figure 10)

Installation of LED Lamps:

1. ADJUSTABLE FITTER MOUNTING (AM)

Step 1: Loosen the four bolts on AM bracket, connect the wires correctly, and pull the wires into the poles. (Figure 11)

Step 2: Place the bracket into the pole and lock the four bolts. (Figure 12)

Notice: Adjustable angle is 0-90° (Figure 11)

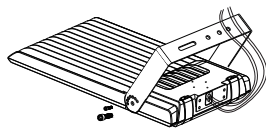

Figure 9

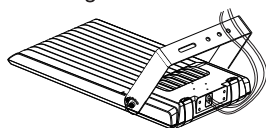

Figure 10

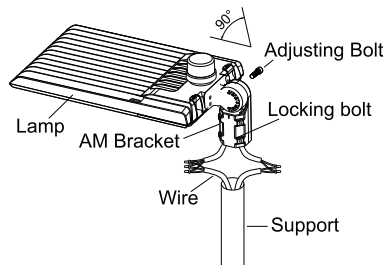

Figure 11

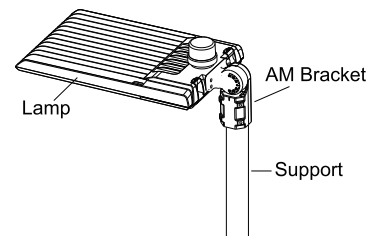

Figure 12



Installation

2. ADJUSTABLE FITTER MOUNTING & DIRECT MOUNTING (AM&DM)

2.1 ADJUSTABLE FITTER MOUNTING

Step 1: Remove the spare parts from A&D bracket. (Figure 13).

Step 2: Loosen the four bolts on A&D bracket, connect the wires correctly, and pull the wires into the poles. (Figure 14)

Step 3: Place the bracket into the pole and lock the four bolts. (Figure 14)

Notice: Adjustable angle is 0-90° (Figure 14)

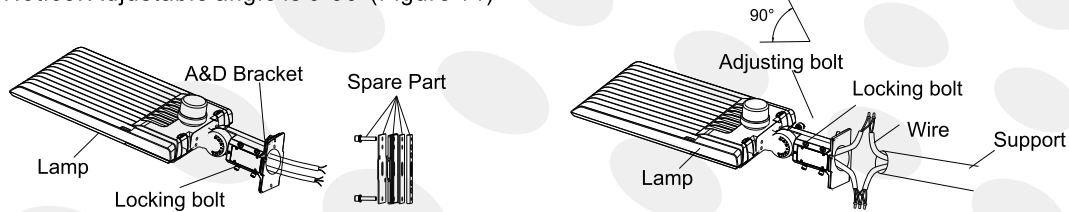

Figure 13

Figure 14

2.2 DIRECT MOUNTING

Step 1: Remove the four bolts from A&D bracket, remove the four rubber plugs from installation bar, put the four rubber plugs on the place where the four bolts were previously placed on the bracket for waterproof purpose (Figure 15)

Step 2: Fix A&D bracket to square pole with bolt, open the cover of A&D bracket junction box, pull the wire into bracket junction box, connect the wire properly and cover the junction box. (Figure 16)

Notice: Adjustable angle is 0-90°. (Figure 16)

Same as round pole installation, please remember to use the adapting plate for round pole installation (Figure 17)

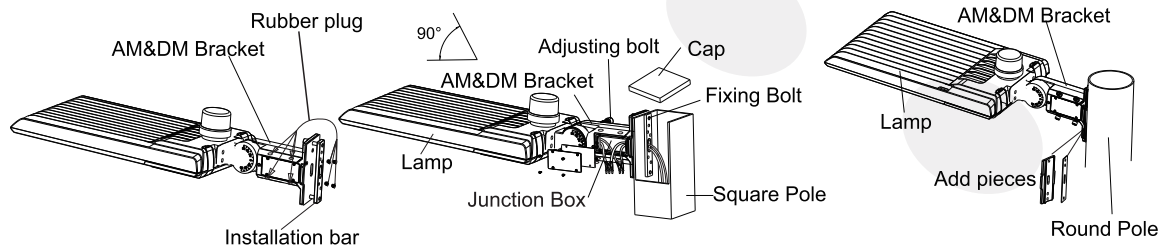

Figure 15

Figure 16

Figure 17

3. DIRECT MOUNTING (DM)

Step 1: Fix DM bracket to square pole with bolt, open the side lid of DM bracket, pull the wire into junction box, and connect the wire correctly. (Figure 18)

Step 2: Put the connected wire into the junction box, then cover the junction box. (Figure 19)

Notice: Adjustable angle is 0-35° (Figure 18).

Same as round pole installation, please remember to remove the silicon plate when install the fixture in round pole (Figure 20)

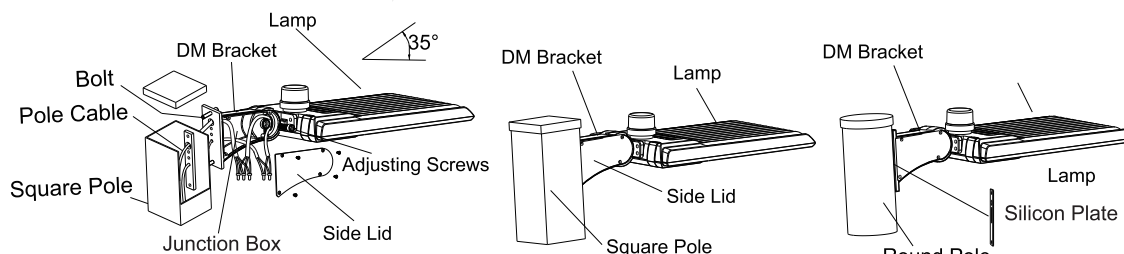

Figure 18

Figure 19

Figure 20



ZOHO™

4th Gen. Premium

Installation

4. YOKE MOUNTING (YM)

Step 1: Drill holes on the wall as shown. (Figure 21)

Step 2: Knock the expansion bolts into the wall. (Figure 22)

Step 3: Connect the fixture to the bracket and tighten the screws; connect the wires properly and put them into junction box. (Figure 23)

Notice: Adjustable angle is 0-90° (Figure 23)

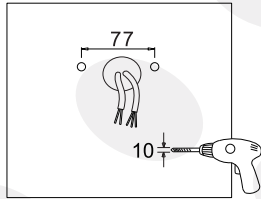

Figure 21

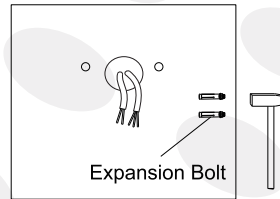

Figure 22

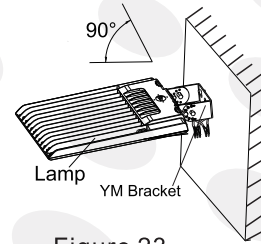

Figure 23

5. FLOOD MOUNTING (FM)

Install the mount to the fixture, tighten the mount and install the screws. (Figure 24)

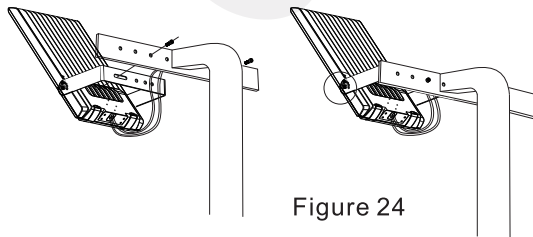
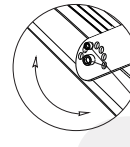

Figure 24



Loosen the angle to adjust the screw, after adjust to the angle that you need, then tighten the screws.

Instructions for Photocell

When the photocell function is required, photocell should be installed on the back of lamp; When it's not required, shorting cap should be installed on the back of lamp (Figure 25)

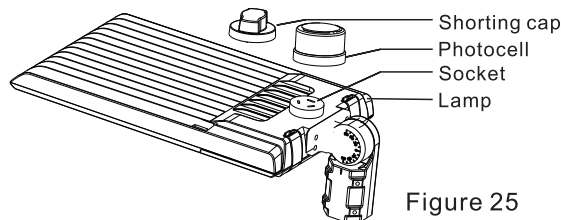

Figure 25

Standard wire:

L/live wire: Black\Brown;

N/null wire: White\Blue;

Ground wire: Green\Yellow-green.

MIN 75 °C SUPPLY CONDUCTOR

THIS PRODUCT MUST BE INSTALLED IN ACCORDANCE WITH THE APPLICABLE INSTALLATION CODE BY A PERSON FAMILIAR WITH THE CONSTRUCTION AND OPERATION OF THE PRODUCT AND THE HAZARDS INVOLVED.

LES FILS D'ALIMENTATION 75 °C MIN

CE PRODUIT DOIT ÊTRE INSTALLÉ SELON LE CODE D'INSTALLATION PERTINENT, PAR UNE PERSONNE QUI CONNAÎT BIEN LE PRODUIT ET SON FONCTIONNEMENT AINSI QUE LES RISQUES INHÉRENTS.



Wiring Diagram

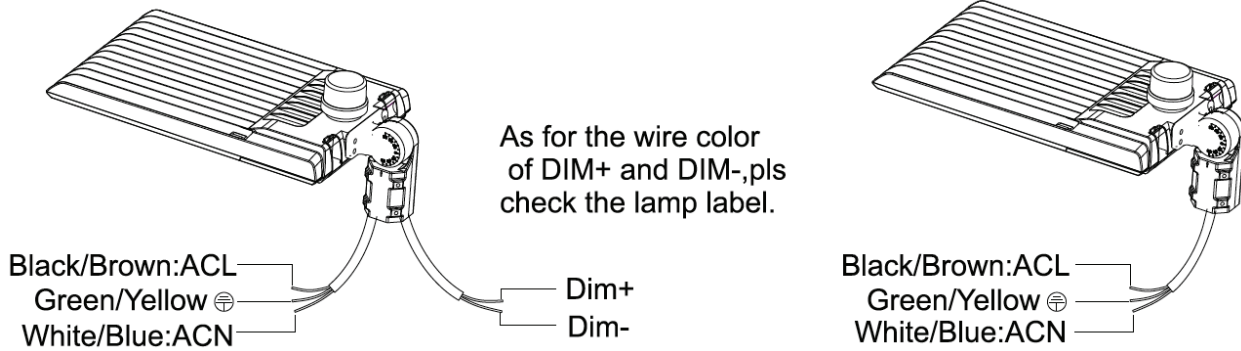

Packaging Info for SKU # 153500

Bracket Type	Size	Qty	N.W. / Box	G.W. / Box
Yoke Mount	25.60 X 15.16 X 6.10 in	1 PC	14.33 lbs	16.53 lbs
Universal Mount	25.60 X 15.16 X 6.10 in	1 PC	14.33 lbs	16.53 lbs

Tolerance of Carton Size: ±15 MM, Tolerance of Weight: ±10%.

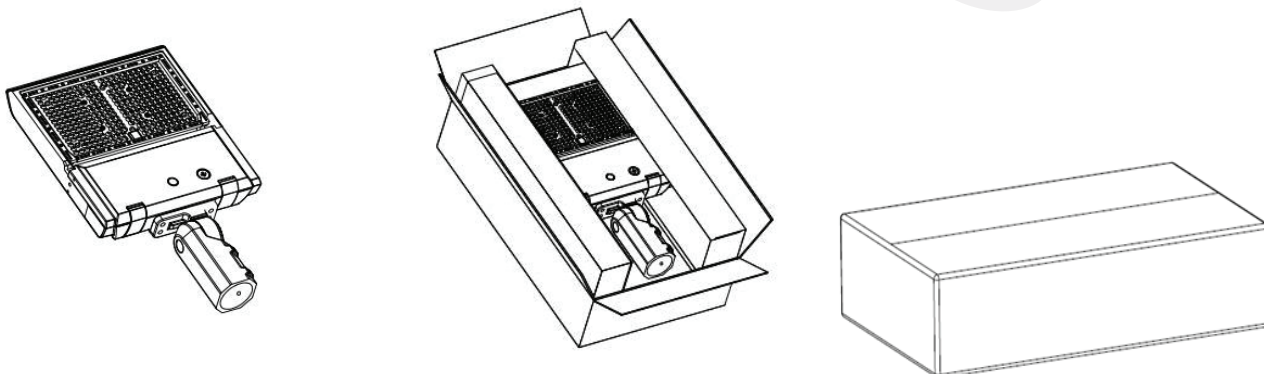



ZOHO™

4th Gen. Premium

Packaging Info for SKU # 153507

Bracket Type	Size	Qty	N.W. / Box	G.W. / Box
Yoke Mount	33.07 X 15.16 X 6.10 in	1 PC	20.50 lbs	23.28 lbs
Universal Mount	33.07 X 15.16 X 6.10 in	1 PC	21.16 lbs	24.003 lbs

Tolerance of Carton Size: ± 15 MM, Tolerance of Weight: $\pm 10\%$.

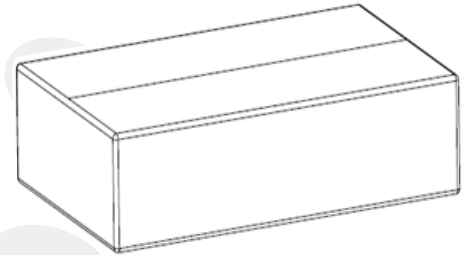
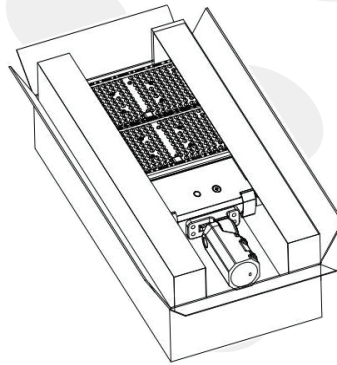
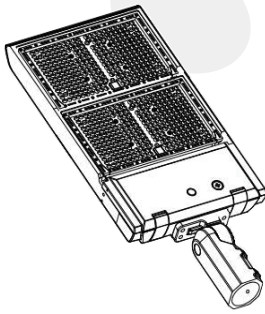



Application Image



LED AREA LIGHT



ZOHO™

4th Gen. Premium

Safety Precautions

To reduce the risk of death, personal injury or property damage from fire, electric shock, falling parts, cuts/abrasions, and other hazards read all warnings and instructions included with and on the fixture box and all fixture labels. Before installing, servicing, or performing routine maintenance upon this equipment, follow these general precautions. Commercial installation, service and maintenance of luminaires should be performed by a qualified licensed electrician.

For the installation: If you are unsure about the installation or maintenance of the luminaires, consult a qualified licensed electrician and check your local electrical code. To prevent wiring damage or abrasion, do not expose wiring to edges of sheet metal or other sharp objects. Do not make or alter any open holes in an enclosure of wiring or electrical components during kit installation.

WARNING: RISK OF FIRE OR ELECTRICAL SHOCK

Turn off electrical power at fuse or circuit breaker box before wiring fixture to the power supply. Turn off the power when you perform any maintenance. Verify that supply voltage is correct by comparing it with the luminaire label information. Make all electrical and grounded connections in accordance with the National Electrical Code and any applicable local code requirements. All wiring connections should be capped with UL approved wire connectors.

CAUTION: RISK OF INJURY

Avoid direct eye exposure to the light source while it is on. Account for small parts and destroy packing material, as these may be hazardous to children.

Warranty

5 Years Warranty